

STRUXX

SIZE IT UP!™



SUPER SCALE
GRAN | ESCALA
SURDIMENSIONE
RESIGE
SUPERGROOT
GRANDI | DIMENSIONI
GRANDE | ESCALA



www.struXXworld.com



8+ | 6015 | Basixx 20x™



1x
AMI5631B



1x
AMI5632B



11x
AMI5633B



2x
AMI5684AGV



2x
AMI5606AGV



4x
AMI5619AGV



5x
AMI5611AGV



1x
AMI5601KM



3x
AMI5664AGV



6x
AMI5607AGV



2x
AS060159



4x
AS060153



2x
AS060154



1x
AS060158



2x
AMI5691AGV



16x
AMI5605KM



4x
AS060157



13x
AMI5613B



30x
AS060151



12x
AMI5646AGV



15x
AMI5621AGV



18x
AMI5622AGV



5x
AMI5623AGV



2x
AMI5624AGV



8x
AMI5625AGV



1x
AMI5686B



4x
AS060152



10x
AMI5604KM



27x
AMI5603KM



1x
AMI5638B



8x
AMI5698B



6x
AMI5668B



1x
AMI5651A

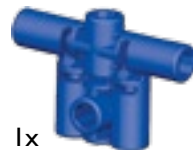

1x
AMI5130B



1x
AMI5637B



2x
AS0601510

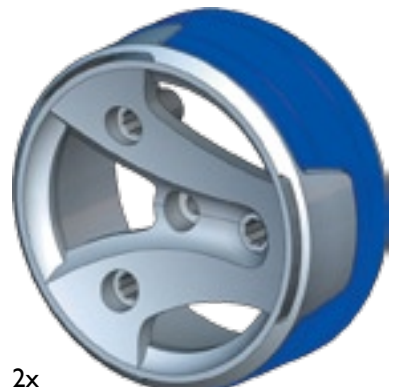

2x
AS0601511

EN Please read these instructions carefully before first use and keep them for future reference. / **ES** Leer estas instrucciones cuidadosamente antes de la primera utilización y guardarlas para referencia futura. / **FR** Il est recommandé de lire attentivement ce feuillet avant la première utilisation et de le conserver pour référence future. / **DE** Die Gebrauchsanleitung bitte durchlesen und aufbewahren. / **NL** Wij raden u aan deze handleiding zorgvuldig te lezen en te bewaren voor eventuele raadpleging op een later tijdstip. / **IT** Leggere le istruzioni prima di cominciare ad usare il gioco e conservarle per referenze future. / **PT** Leia as instruções antes do primeiro uso e guarde-as para futura referência.

EN ⚠ **WARNING :**
CHOKING HAZARD. - Small parts.
Toy contains a small ball.
Not for children under 3 years.

ES ⚠ **ADVERTENCIA :**
PELIGRO DE ASFIXIA. - Contiene piezas pequeñas.
El juguete contiene una bola pequeña.
No recomendado para niños menores de 3 años.

FR ⚠ **AVERTISSEMENT :**
RISQUE DE SUFFOCATION. - Présence de petits éléments.
Le jouet contient une petite balle.
Ne convient pas aux enfants de moins de 3 ans.

DE ⚠ **WARNUNG :**
ERSTICKUNGSGEFÄHR. - Enthält kleine Teile.
Ein kleiner Ball ist im Spielzeug inbegriffen.
Nicht für Kinder unter 3 Jahren geeignet.

EN Latex free toy.

ES Juguete sin látex.

FR Jouet sans latex.

DE Latexfreies Spielzeug.

NL Speelgoed vrij van latex.

DA Dette legetøj indeholder ikke latexgumi.

EL Παιχνίδι χωρίς λάτεξ

FI Lelu ei sisällä lateksia.

IT Non contiene latex.

NO Lateks fri leketøy.

PT Brinquedo sem conteúdo de latex.

SV Leksak utan latex.

JA この玩具にはラテックスは使用されていません。

ZH 無乳膠玩具。

AR لعبة خالية من مادة اللاتكس

NL ⚠ **WAARSCHUWING :**
VERSTIKKINGSGEVAAR. - Bevat kleine onderdelen.
Speelgoed bevat een klein balletje.
Niet geschikt voor kinderen onder de 3 jaar.

DA ⚠ **ADVARSEL :**
KVÆLNINGSFARE. - Indeholder smådele.
Legetøjet indeholder en lille bold.
Ikke til børn under 3 år.

EL ⚠ **ΠΡΟΕΙΔΟΠΟΙΗΣΗ :**
ΚΙΝΔΥΝΟΣ ΠΝΙΞΙΜΑΤΟΣ. - Περιέχει μικρά αντικείμενα
Το παιχνίδι περιέχει ένα μπαλάκι.
Όχι για παιδιά κάτω των 3 ετών.

FI ⚠ **VAROITUS :**
TUKEHTUMISVAARA. - Sisältää pieniä osia.
Lelun sisältyy pieni pallo.
Ei alle 3-vuotiaille lapsille.

IT ⚠ **ATTENZIONE :**
PERICOLO DI SOFFOCAMENTO. - Contiene piccole parti.
Il giocattolo comprende una pallina.
Non indicato per bambini sotto i 3 anni.

NO ⚠ **ADVARSEL :**
KVÆLNINGSFARE. - Inneholder små deler.
Leketøy inneholder en liten ball.
Kun for barn over 3 år.

PT ⚠ **ATENÇÃO :**
PERIGO DE ASFIXIA. - Contém peças pequenas.
O brinquedo contém uma pequena bola.
Não é concebido para crianças de menos de 3 anos.

SV ⚠ **VARNING :**
KVÄVNINGSRISK. - Innehåller små delar.
Leksaken innehåller en liten boll.
Inte för barn under 3 år.

JA ⚠ **警告 :**
窒息の危険性 - 小さな部品が含まれています
小さな玉が含まれています。
3歳以下の子供には与えないで下さい。

ZH ⚠ **警告 :**
有窒息危险。 - 包含有小部件
此玩具含有一个小球。
不适合3岁以下的的小孩玩。

AR ⚠ **تحذير :**
خطر اختناق - قطع صغيرة.
تحتوي اللعبة على كرة صغيرة.
غير صالحة للأطفال أقل من 3 سنوات.



Patent pending.
Patente en trámite.
Brevet en instance.
Patent angemeldet.
Patent aangevraagd.
Brevetto in corso.
Patente pendente.

*With the exception of electronic / mechanical parts.
*A excepción de los elementos eléctricos / mecánicos.
*À l'exception des éléments électroniques / mécaniques.
*Mit Ausnahme der elektronischen / mechanischen Teile.
*Met uitzondering van de elektronische / mechanische onderdelen.
*Con l'eccezione di parti elettroniche / meccaniche.
*Com exceção de peças electrónicas/mecânicas.

**LIFETIME GUARANTEE*/GARANTIZADO DE POR VIDA*/GARANTIE À VIE*
LEBENSLANGE GARANTIE*/LEVENSLANGE GARANTIE*/GARANZIA A VITA*/
TEM GARANTIA VITALÍCIA***

COMMENTS, QUESTIONS ? / ¿ COMENTARIOS, PREGUNTAS ? / COMMENTAIRES, QUESTIONS ? / KOMMENTARE, FRAGEN ? / COMMENTAAR, VRAGEN ?
COMMENTI?, DOMANDE? / PERGUNTAS?, COMENTÁRIOS?

1-800-465-MEGA

U.S. & Canada only / Solamente en EEUU y Canadá / É.U. et Canada seulement / Nur für U.S. und Kanada / Uitsluitend in de V.S. en Canada / USA e Canada solamente / Somente EE.UU. e Canadá

www.megabrand.com

Building Tips / Consejos para construir / Conseils pour la construction / Bau-Tipps / Consigli per la costruzione / Bouwtips / Dicas de construção

Sort and organize your parts / Ordena y organiza las piezas / Trie les pièces et range-les par catégories / Sortiere die einzelnen Teile /
Sorteer en orden de onderdelen / Seleziona e ordina i pezzi / Organiza as tuas peças

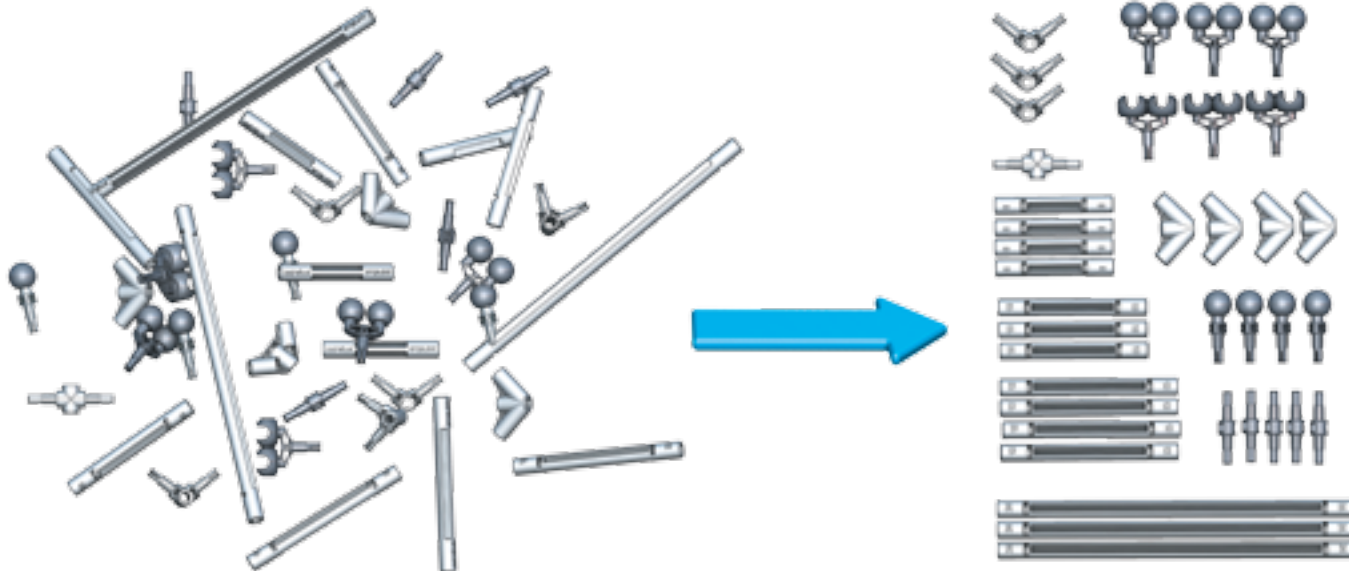

Pay special attention to the different angles of parts / Presta especial atención a los distintos ángulos de las piezas / Fait particulièrement attention aux différents angles des pièces / Achte besonders auf die unterschiedlichen Winkel der Teile / Let goed op, want de onderdelen hebben verschillende hoeken /
Presta attenzione particolare alle diverse angolature dei pezzi / Presta atenção aos diferentes ângulos das peças

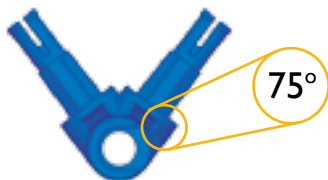

There exists multiple fit positions between parts / Existen multitud de posibilidades para hacer encajar las piezas / Pour chaque pièces , il existe de multiples positions d'assemblages / Es gibt verschiedene Möglichkeiten, die Teile zusammenzufügen / De onderdelen kunnen in verschillende posities worden bevestigd / Esistono diverse possibilità di incastro tra i pezzi / As peças podem ser montadas em posições diferentes

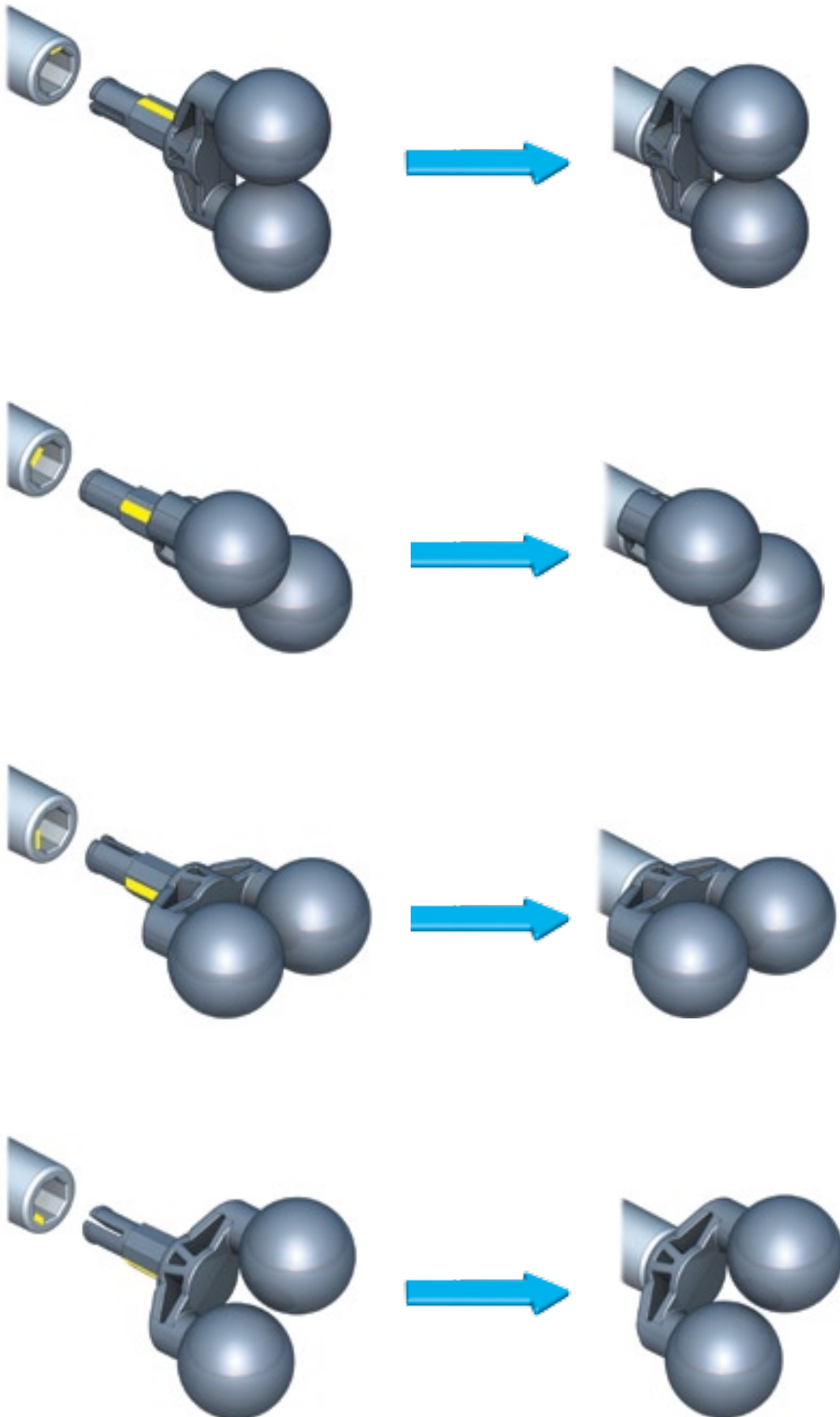

How to assemble / Instrucciones de montaje / Méthodes d'assemblage / So werden die Teile zusammengefügt /
 In elkaar zetten / Assemblaggio / Como montar

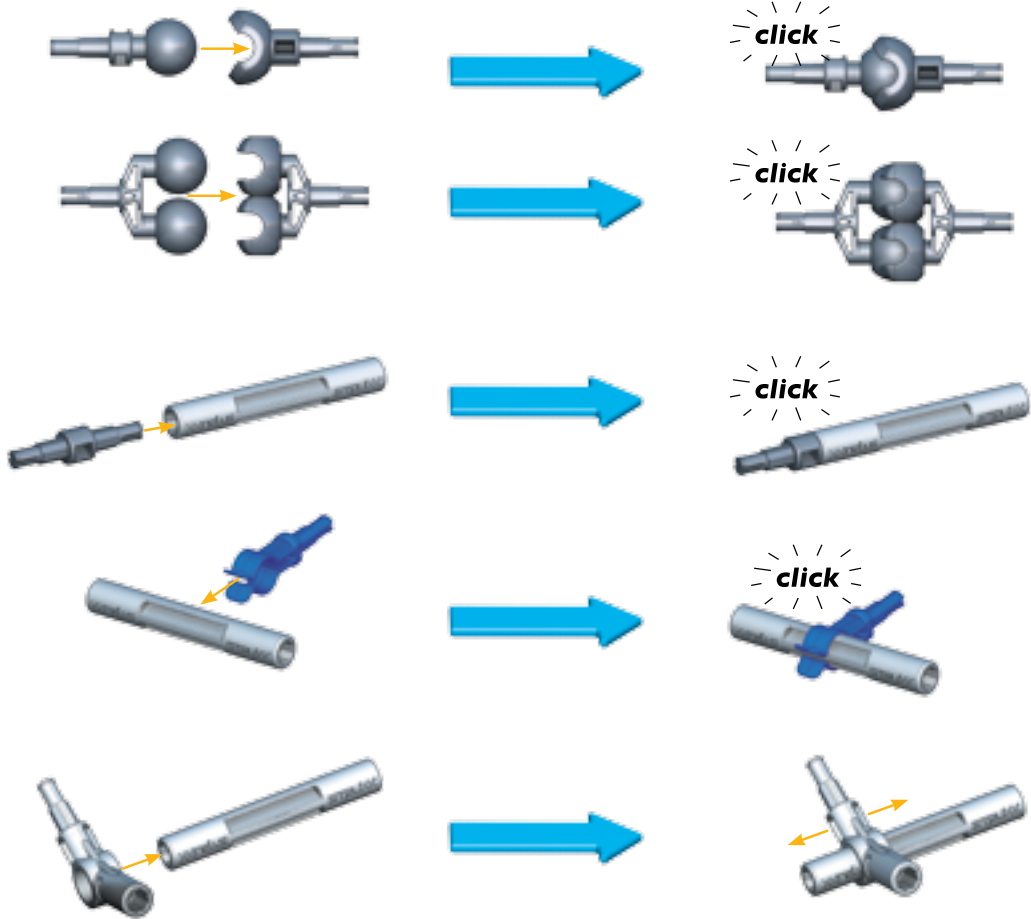

How to disassemble / Instrucciones para desmontar / Méthodes de désassemblage / So werden die Teile auseinandergebaut /
 Uit elkaar halen / Disassemblaggio / Como desmontar

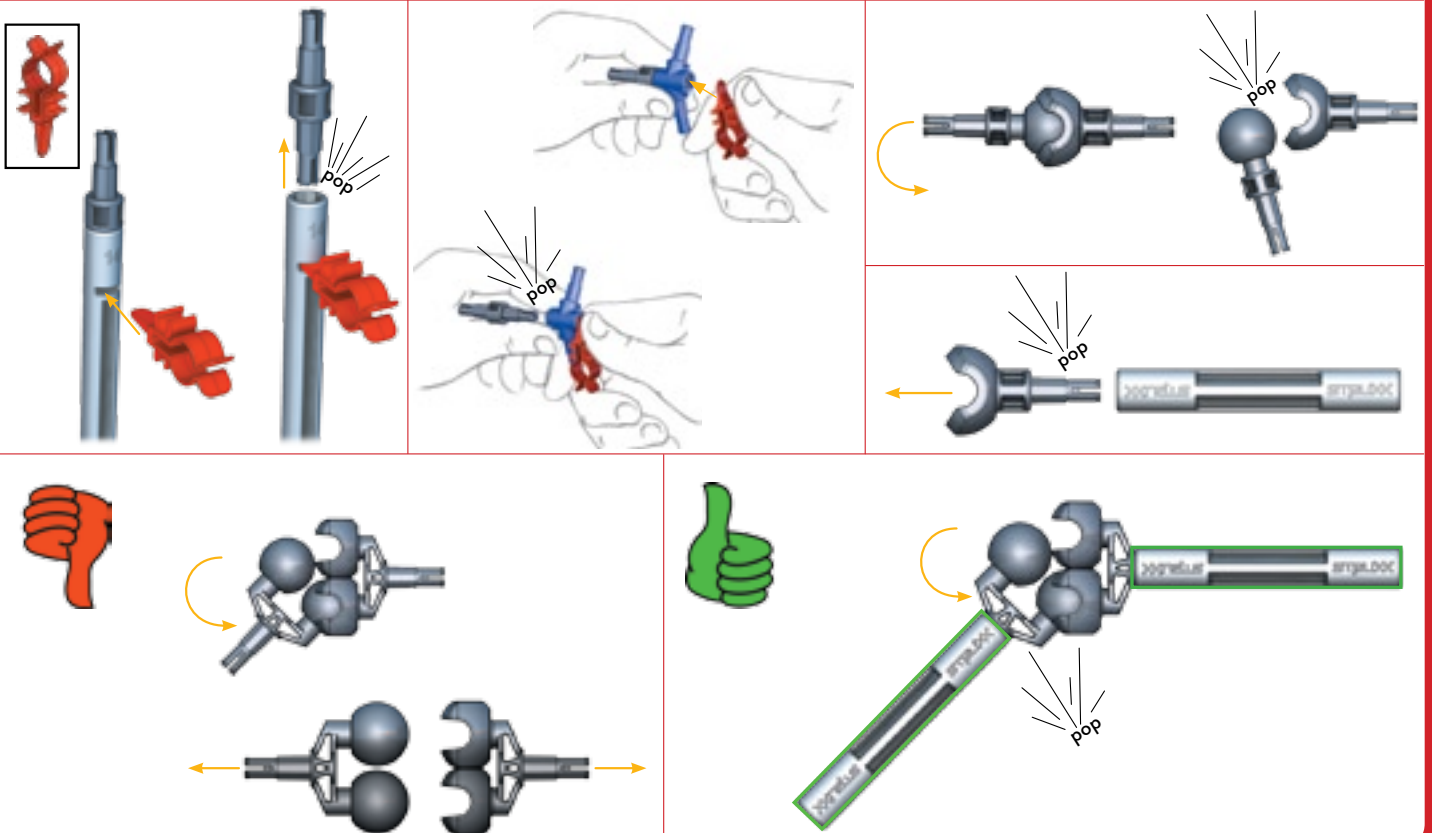

Pay special attention when connecting these parts / Presta especial atención a la hora de conectar las piezas / Assemble ces pièces avec soin dans la position adéquate / Achte darauf, dass du die richtigen Teile miteinander verbindest / Let goed op als je deze onderdelen aan elkaar bevestigt / Presta attenzione particolare quando connetti i seguenti pezzi / Presta especial atenção ao encaixares estas peças



AMI5611AGV



AMI5664AGV



AMI5633B



AMI5632B



AMI5631B

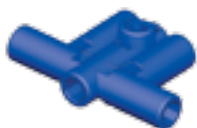

AMI5130B

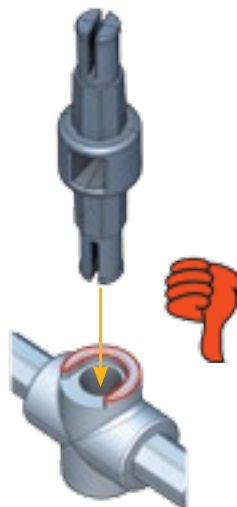

click



click

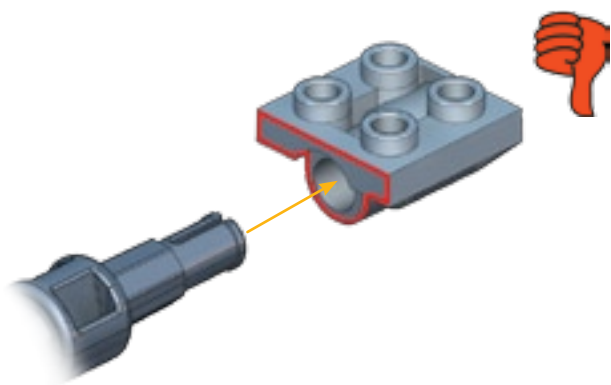

click

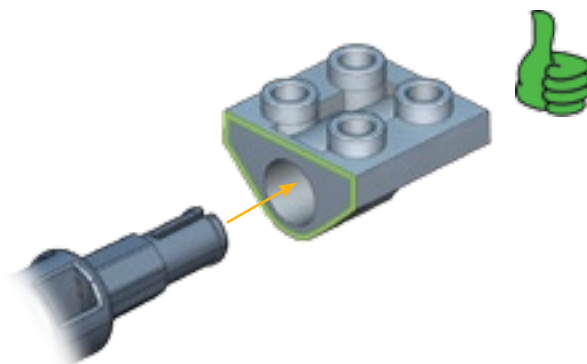
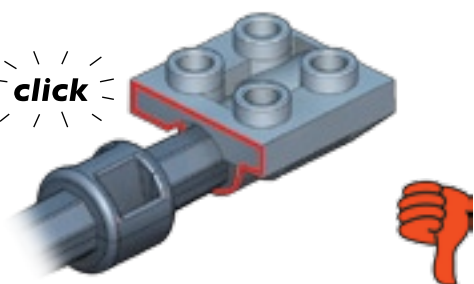

click

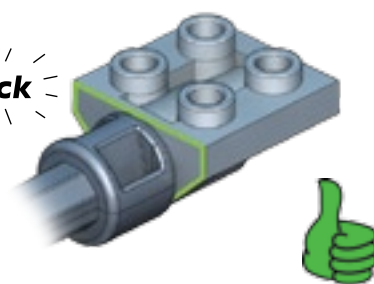

**Build / Construir / Construire / Bauen /
Bouw / Costruisci / Construir**

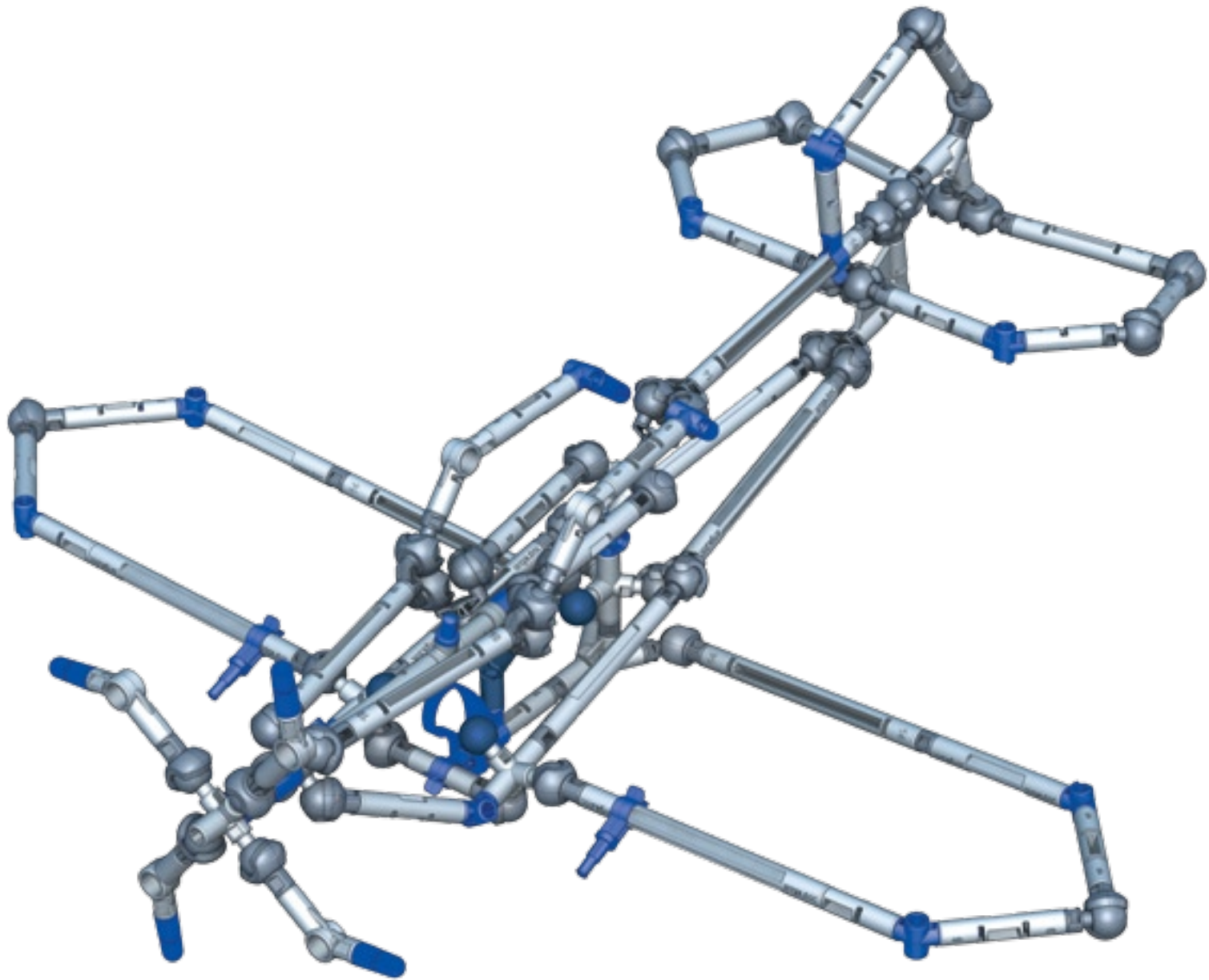

1

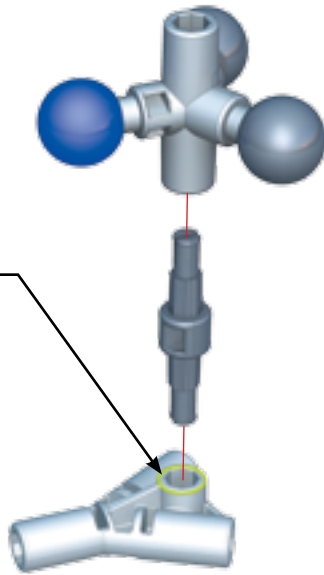
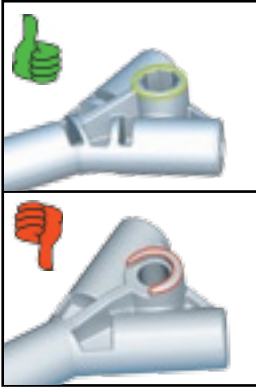
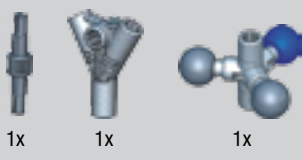

2

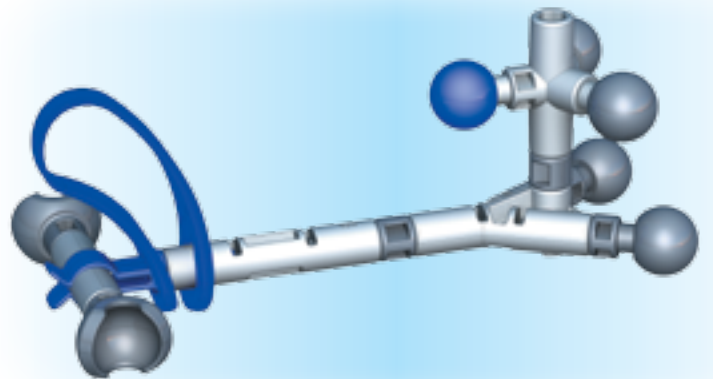
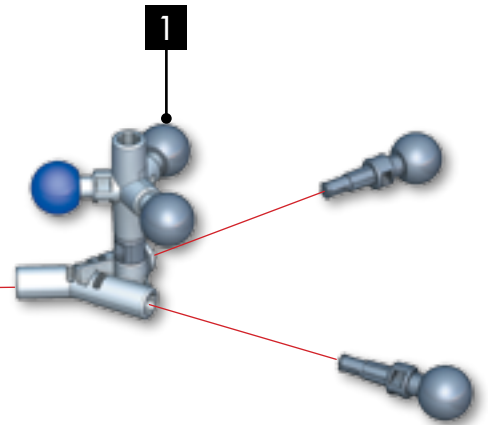
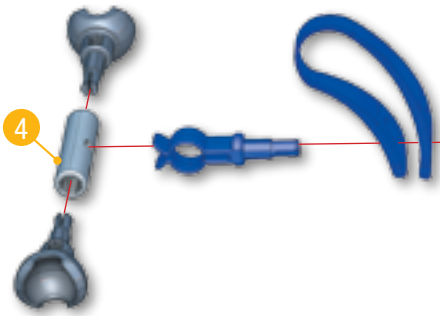
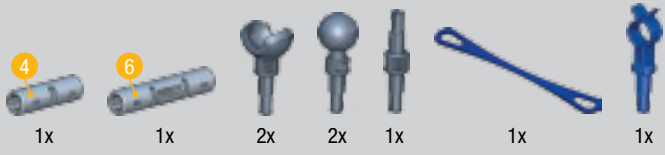

3

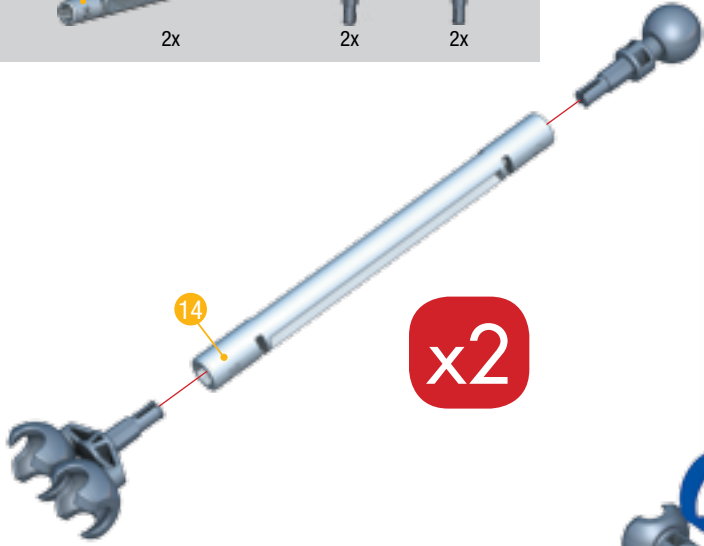
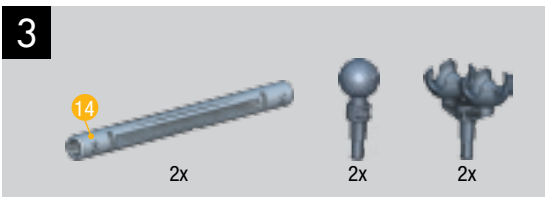

x2

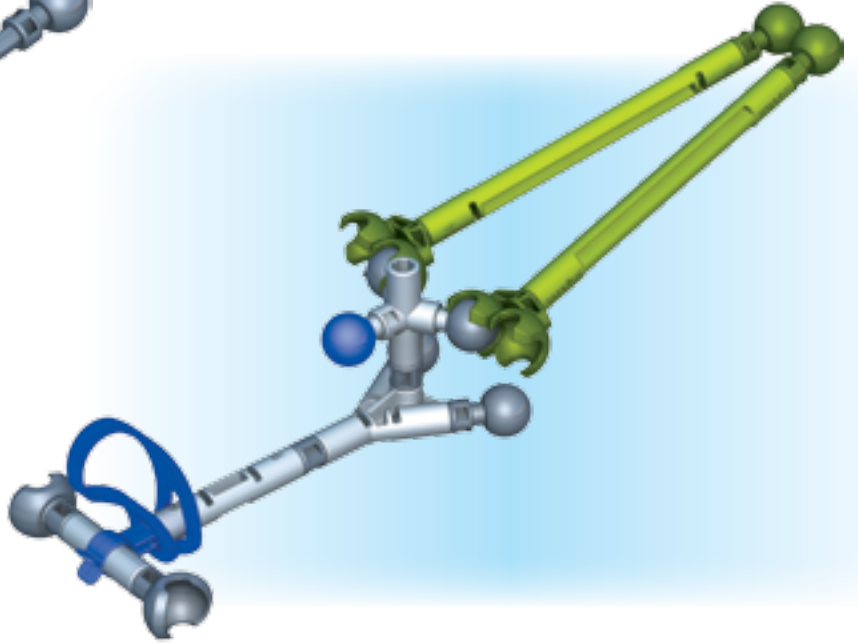

4

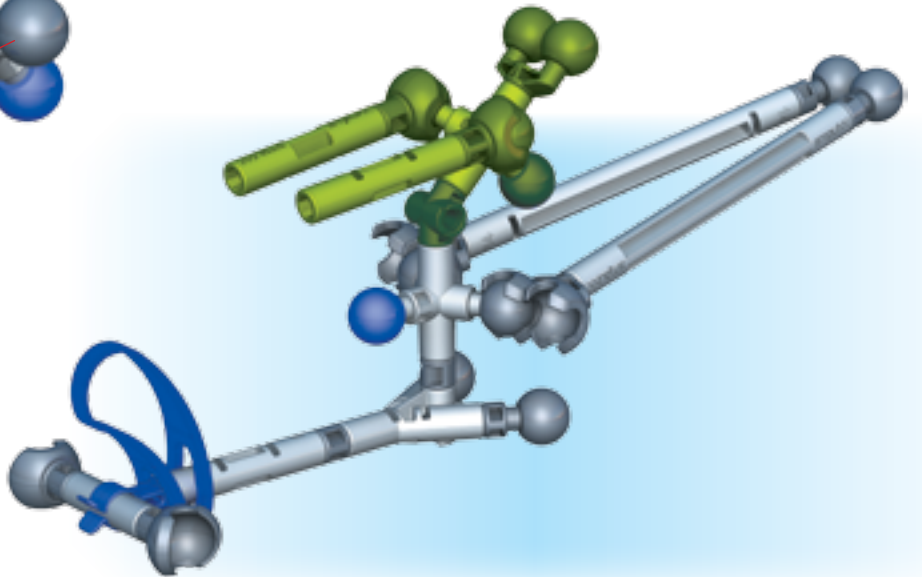
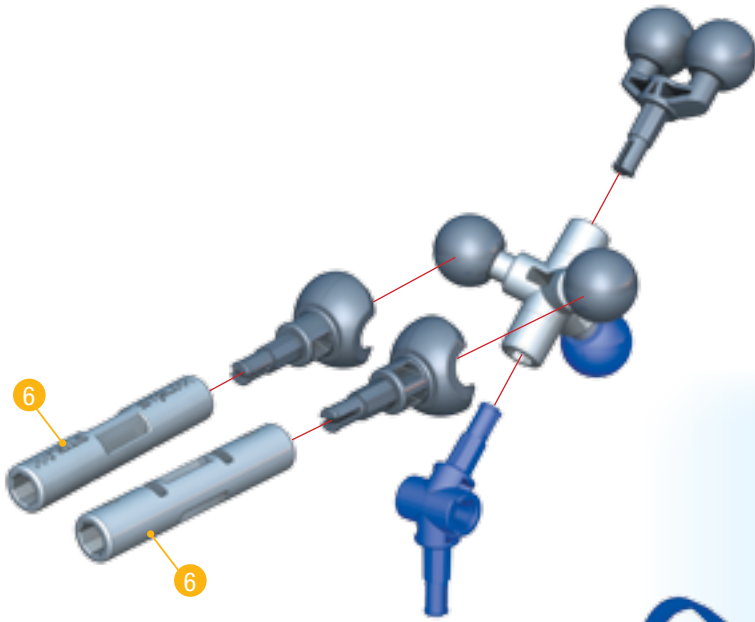
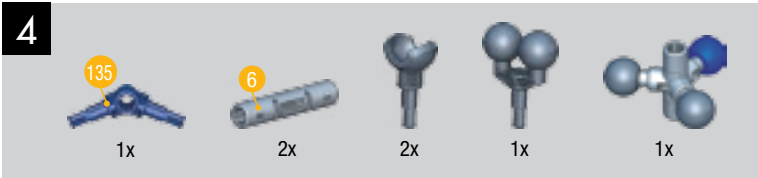

5

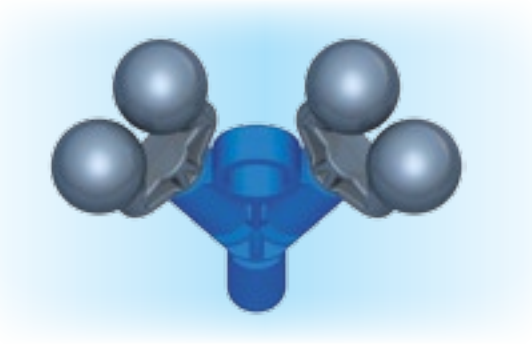
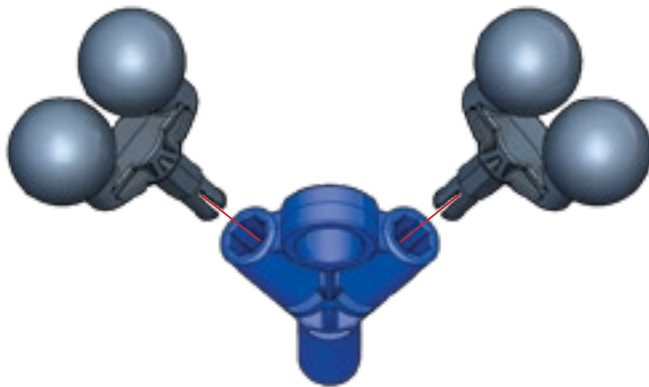
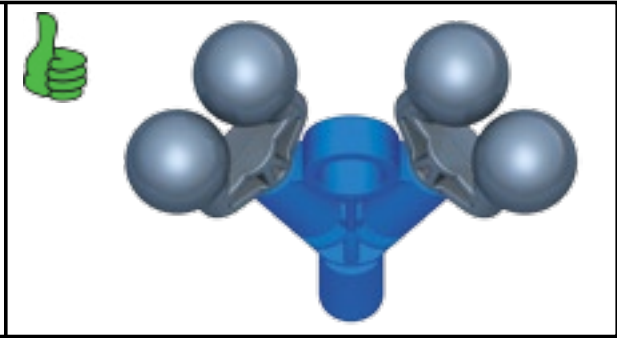
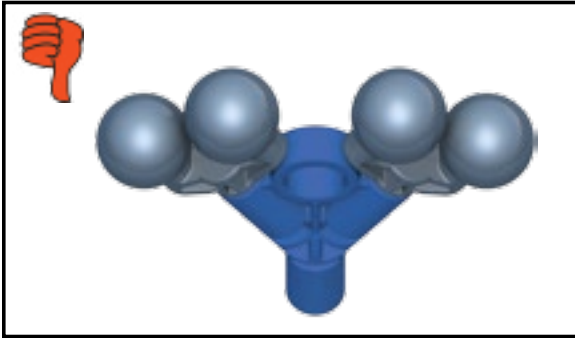

6

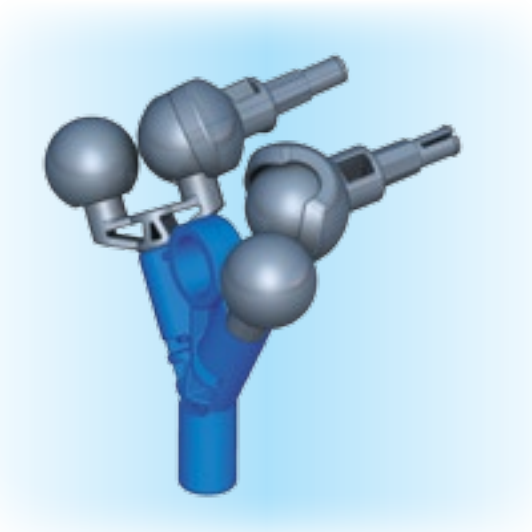
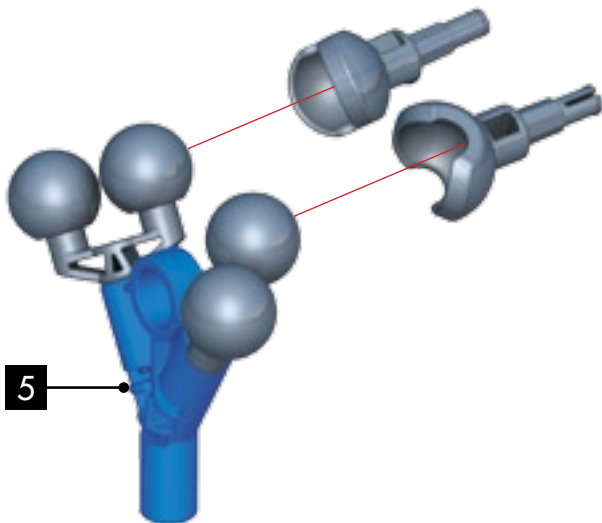

7



1x



1x



1x



1x



1x



1x

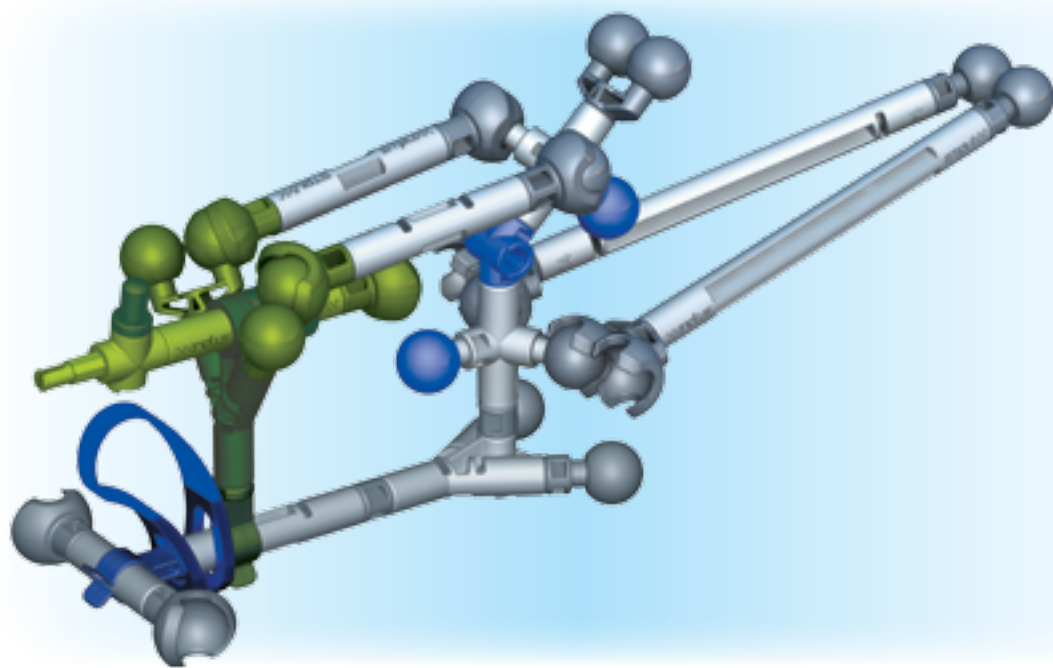
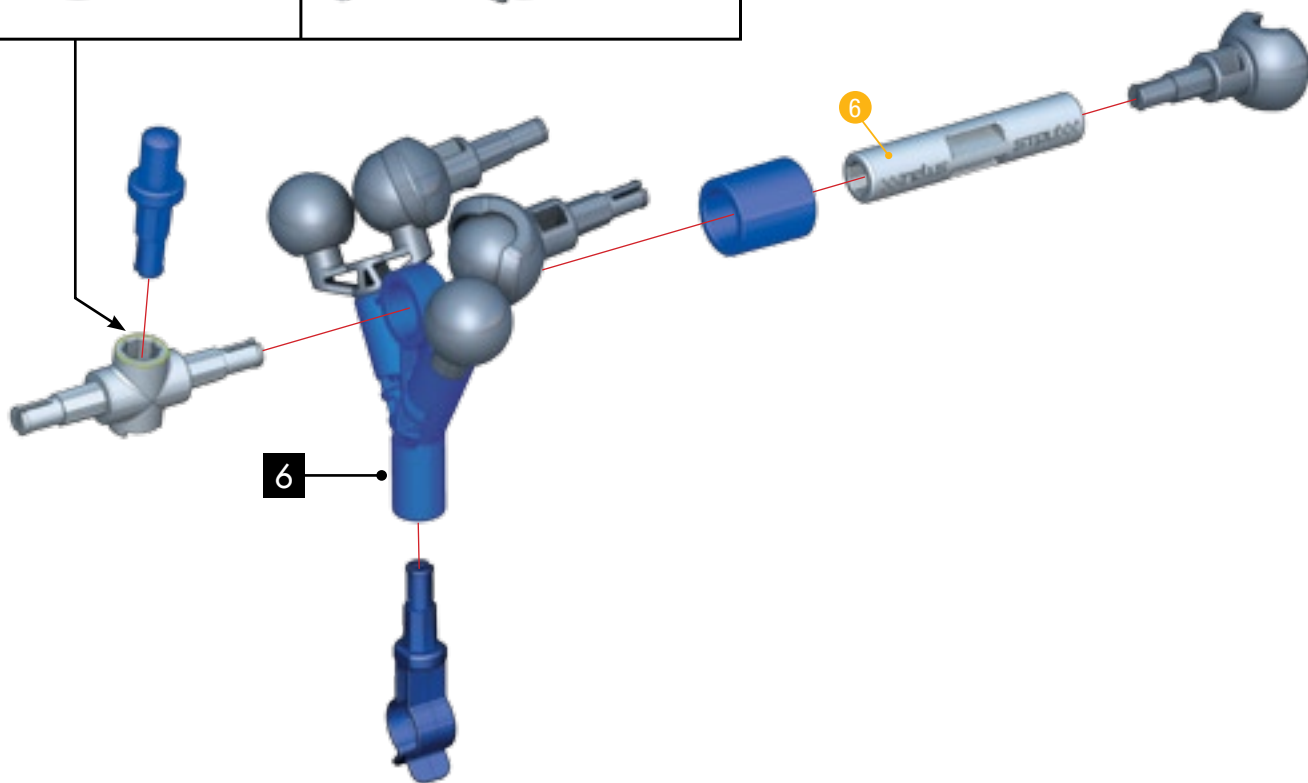
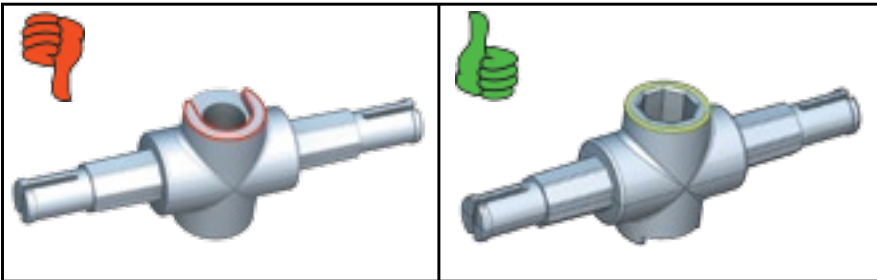

8

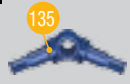

2x



2x



2x



2x



2x



2x



2x

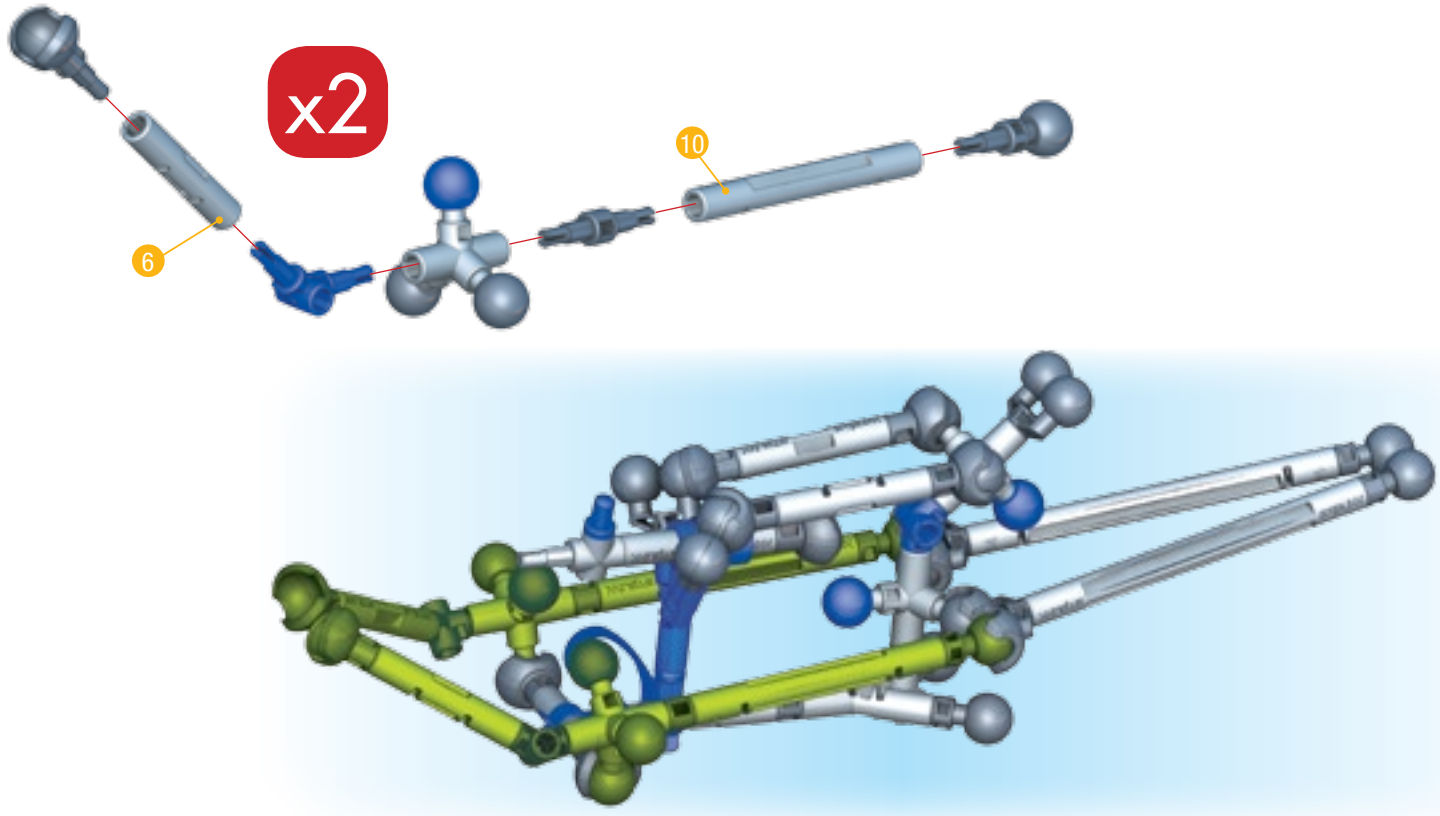

9



2x



2x

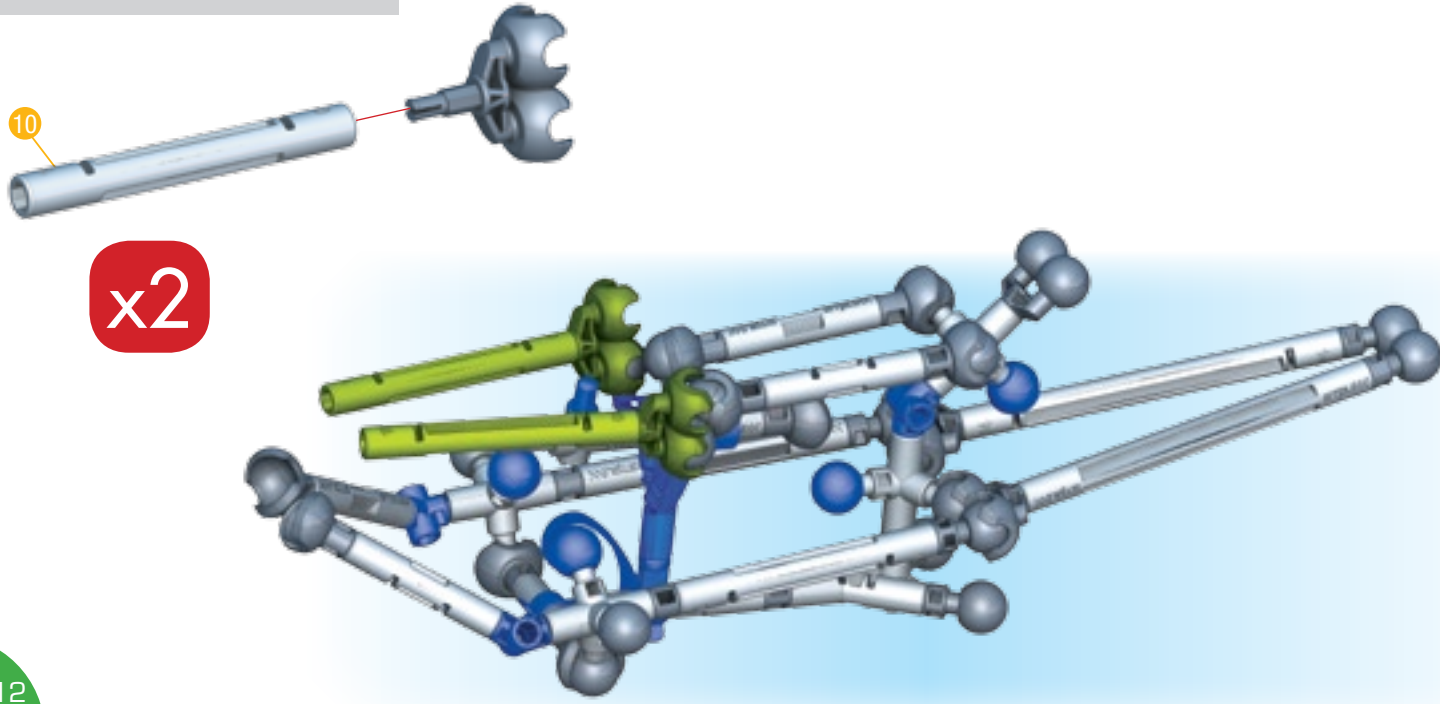

10

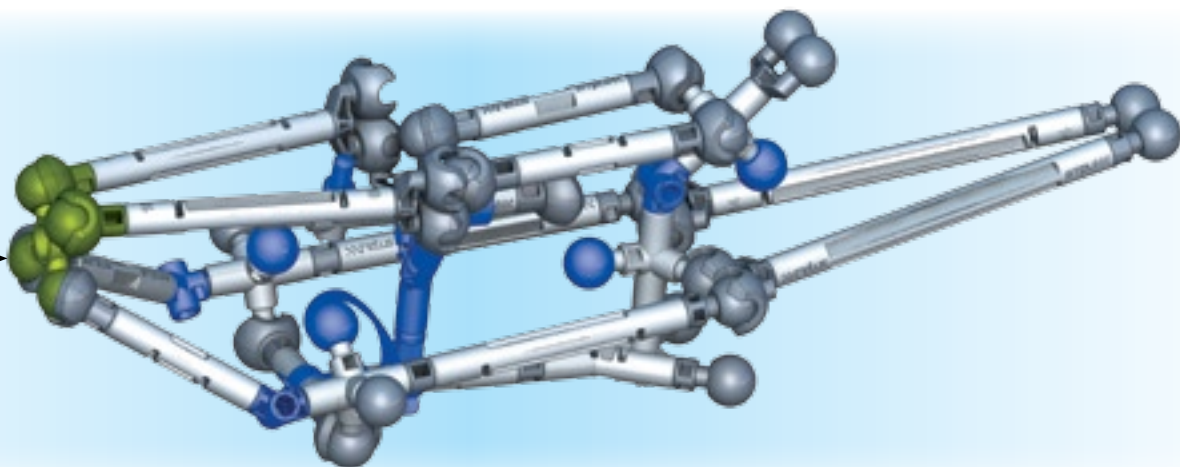
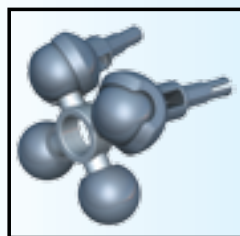
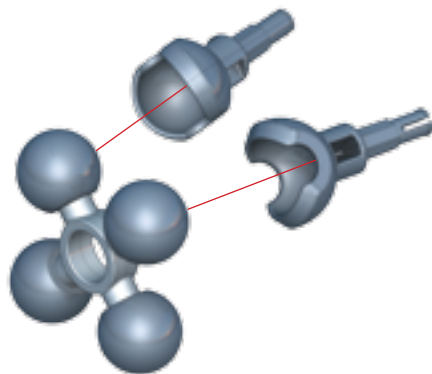
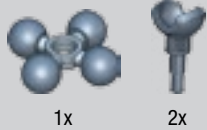

11



x4



12

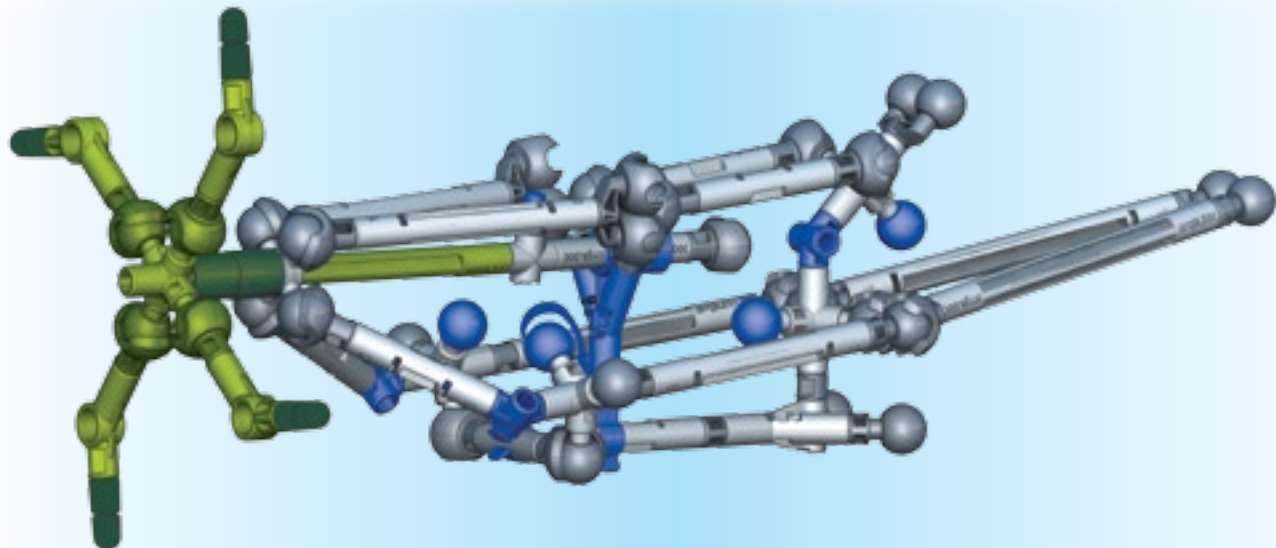
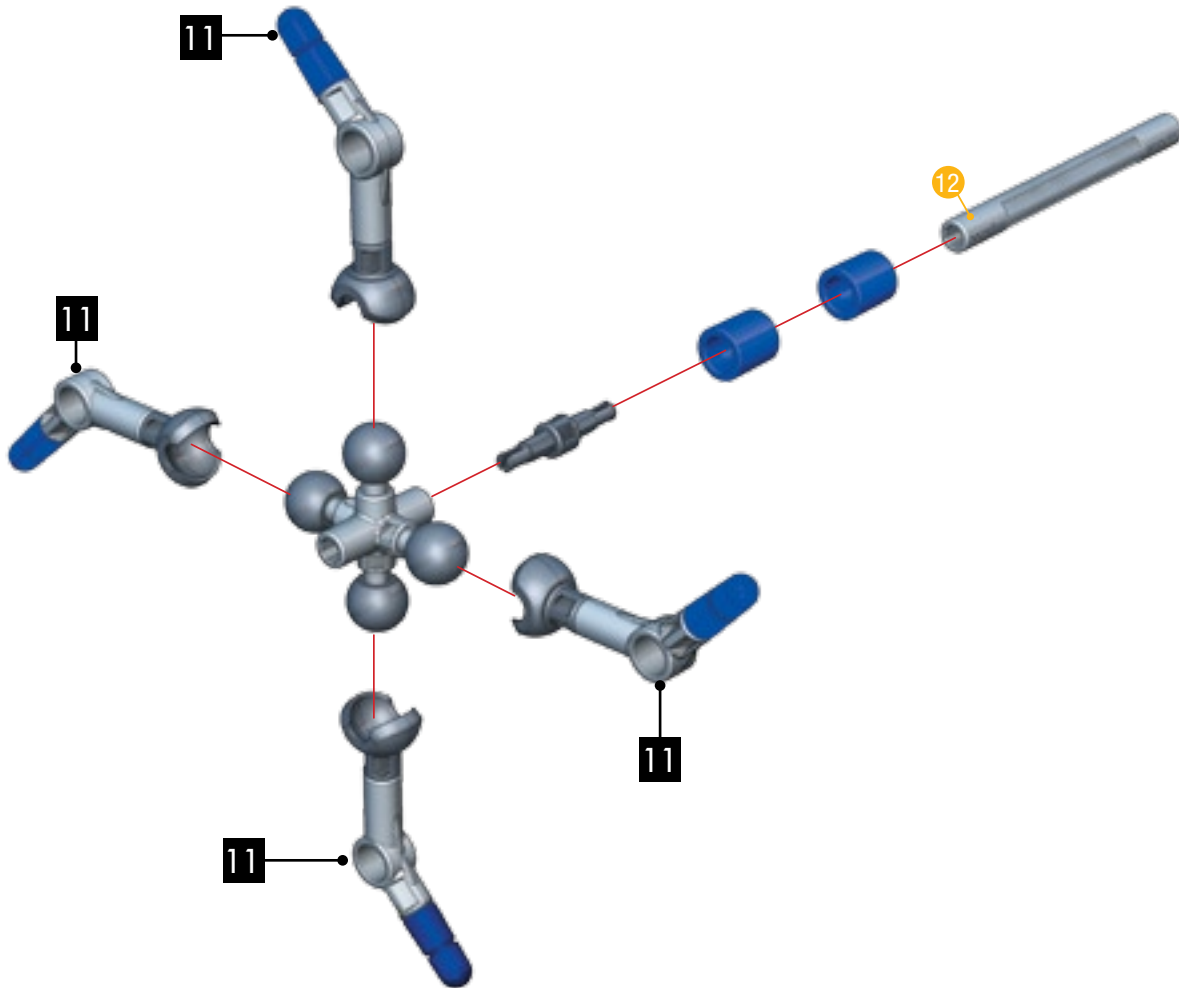
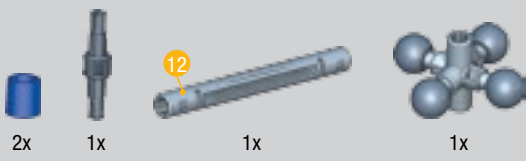

13

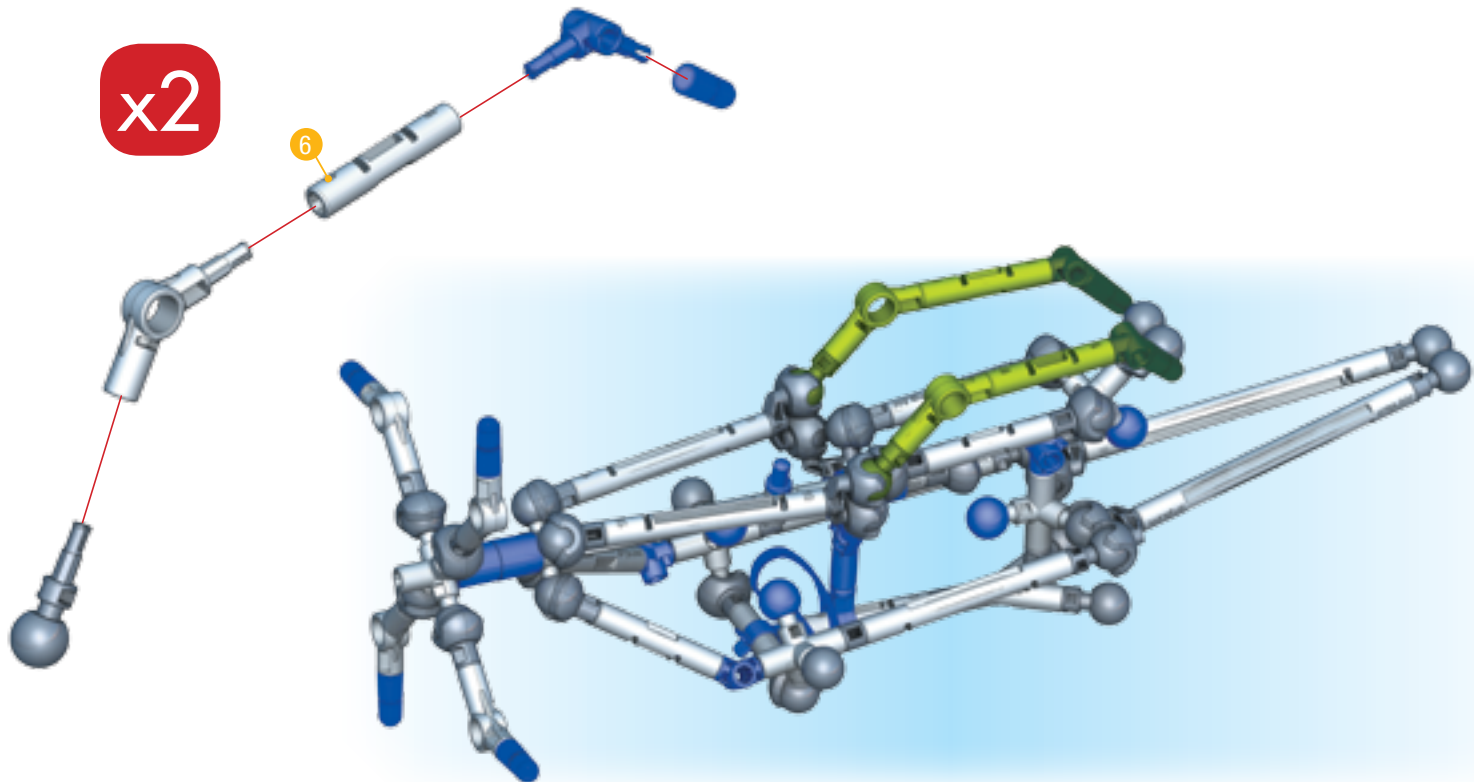
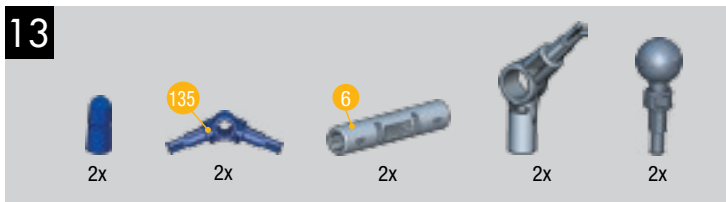

14

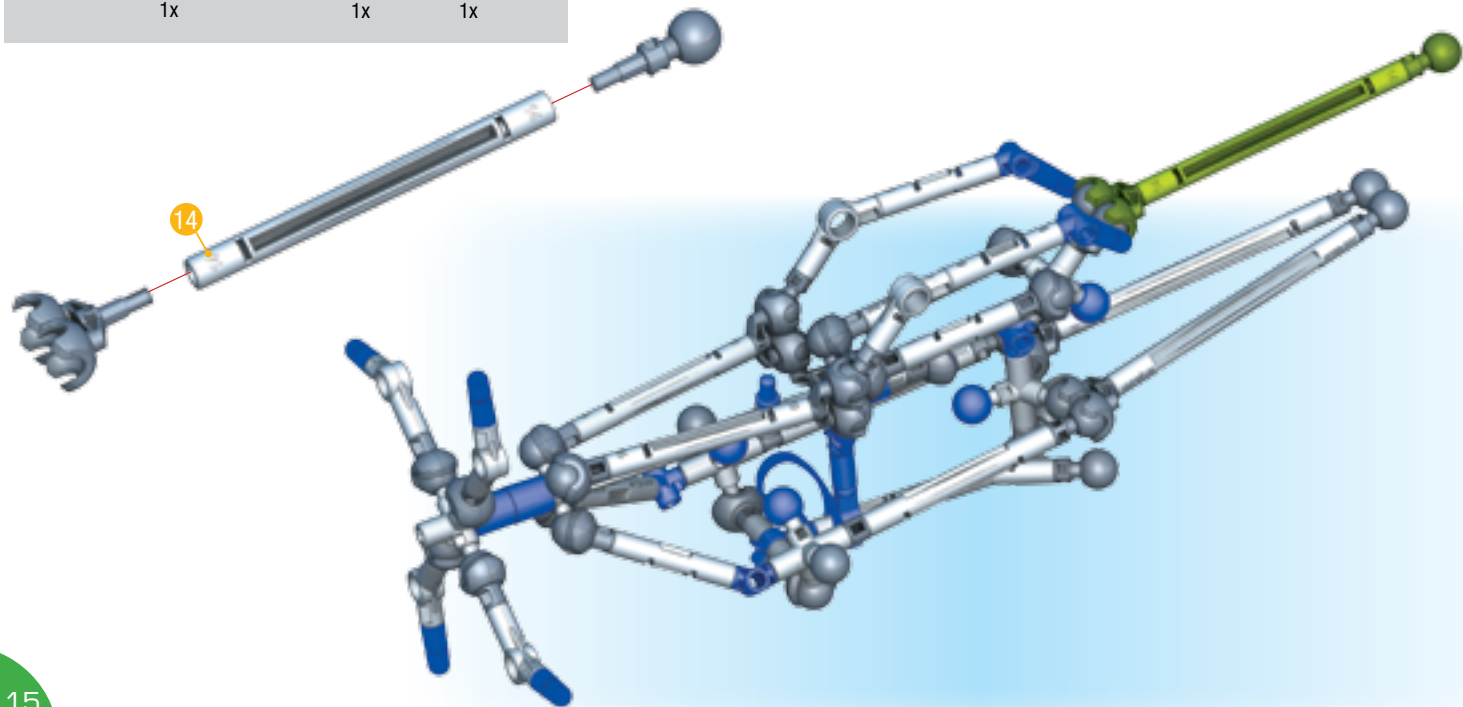
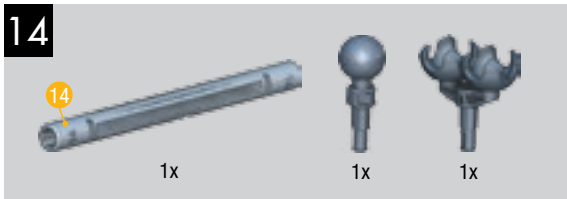

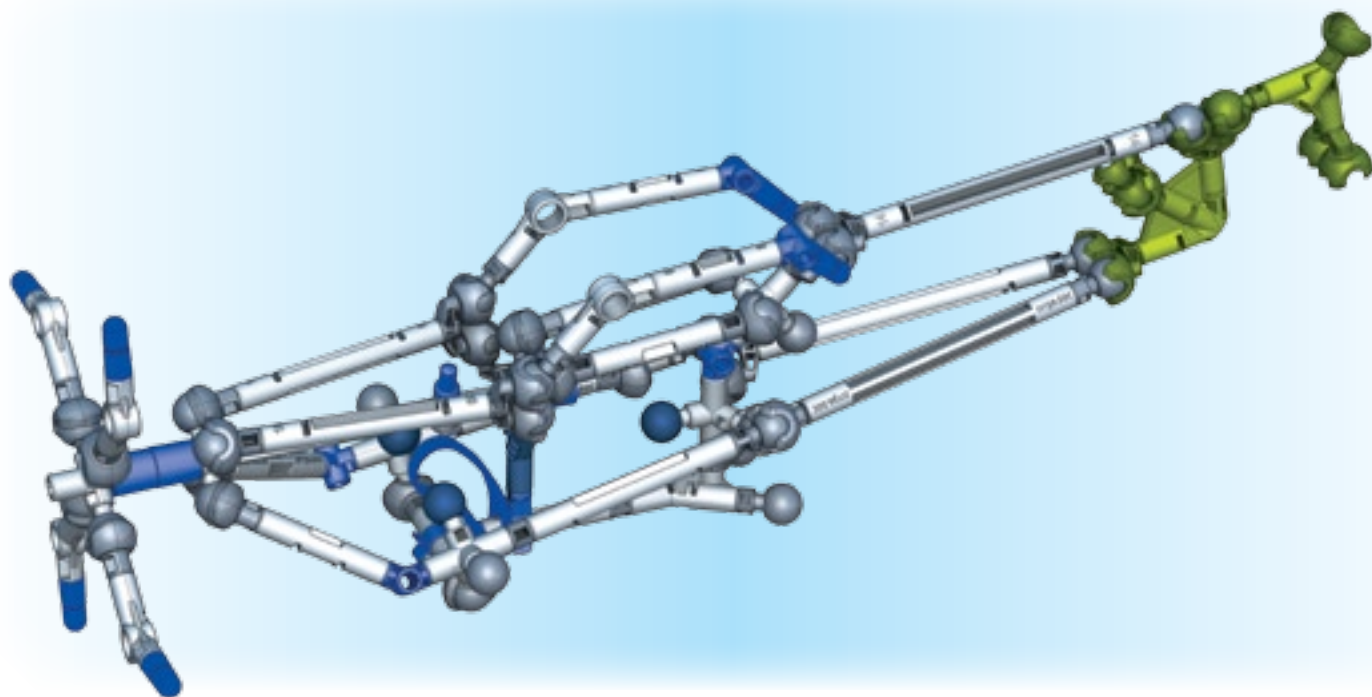
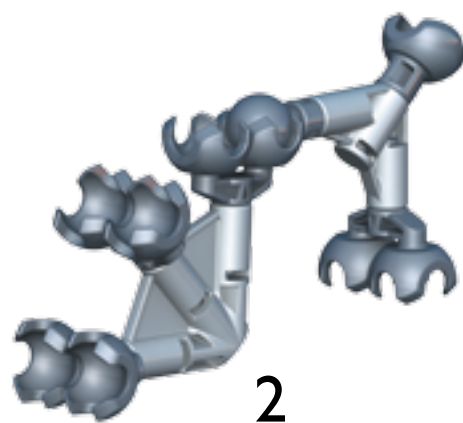
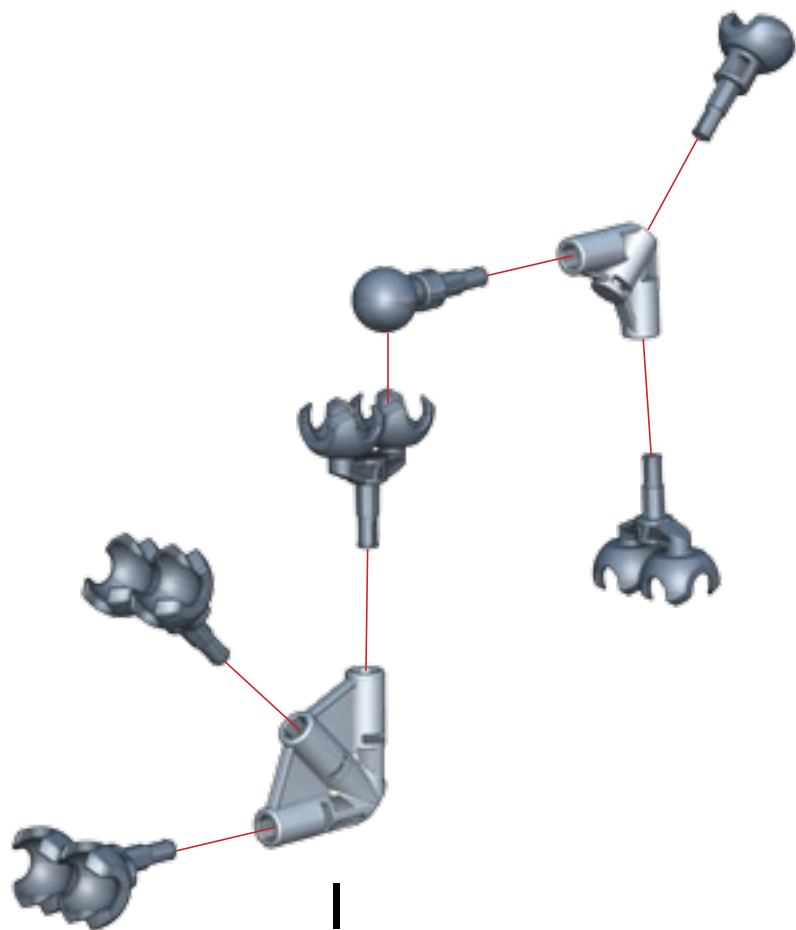
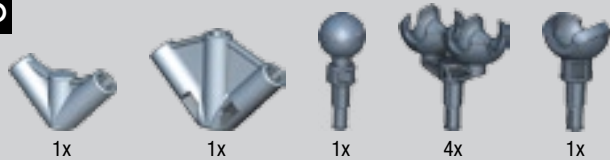



1x

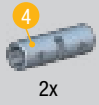

2x



1x



2x



1x



1x

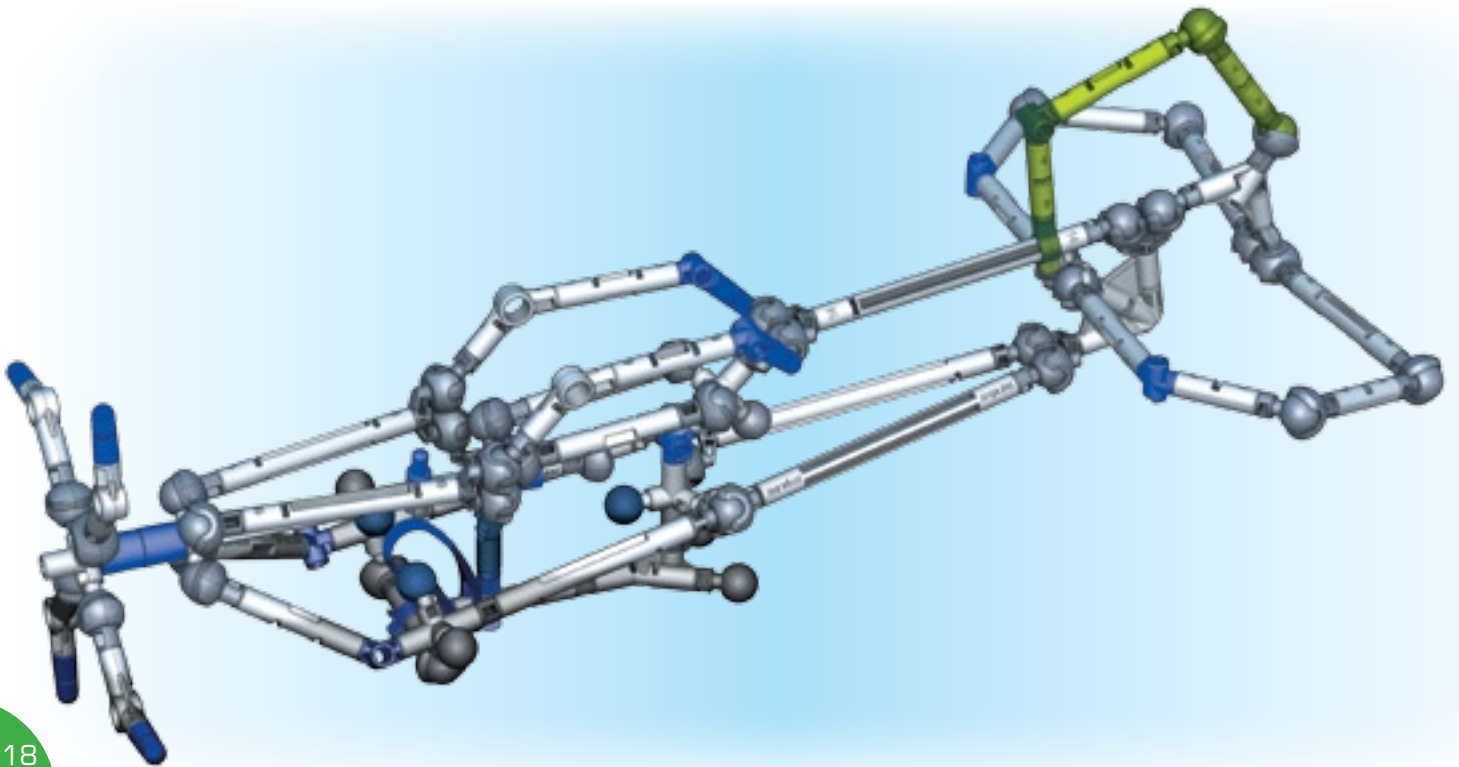
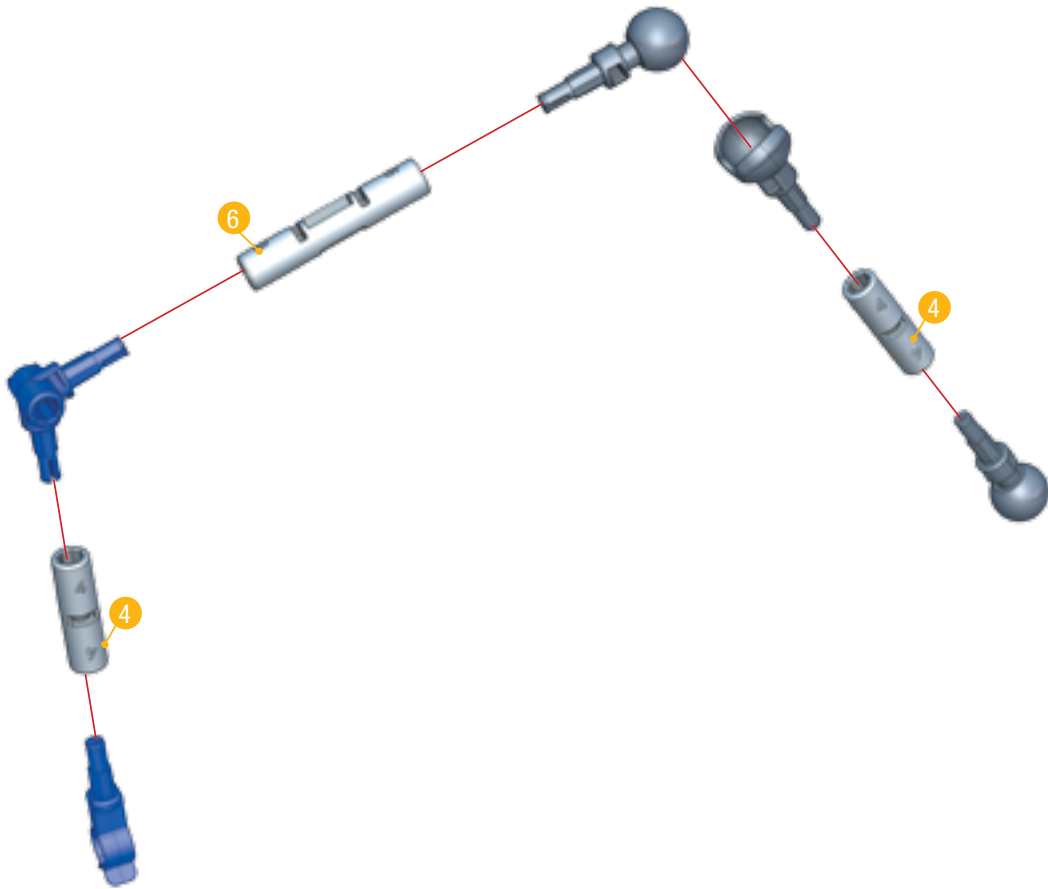

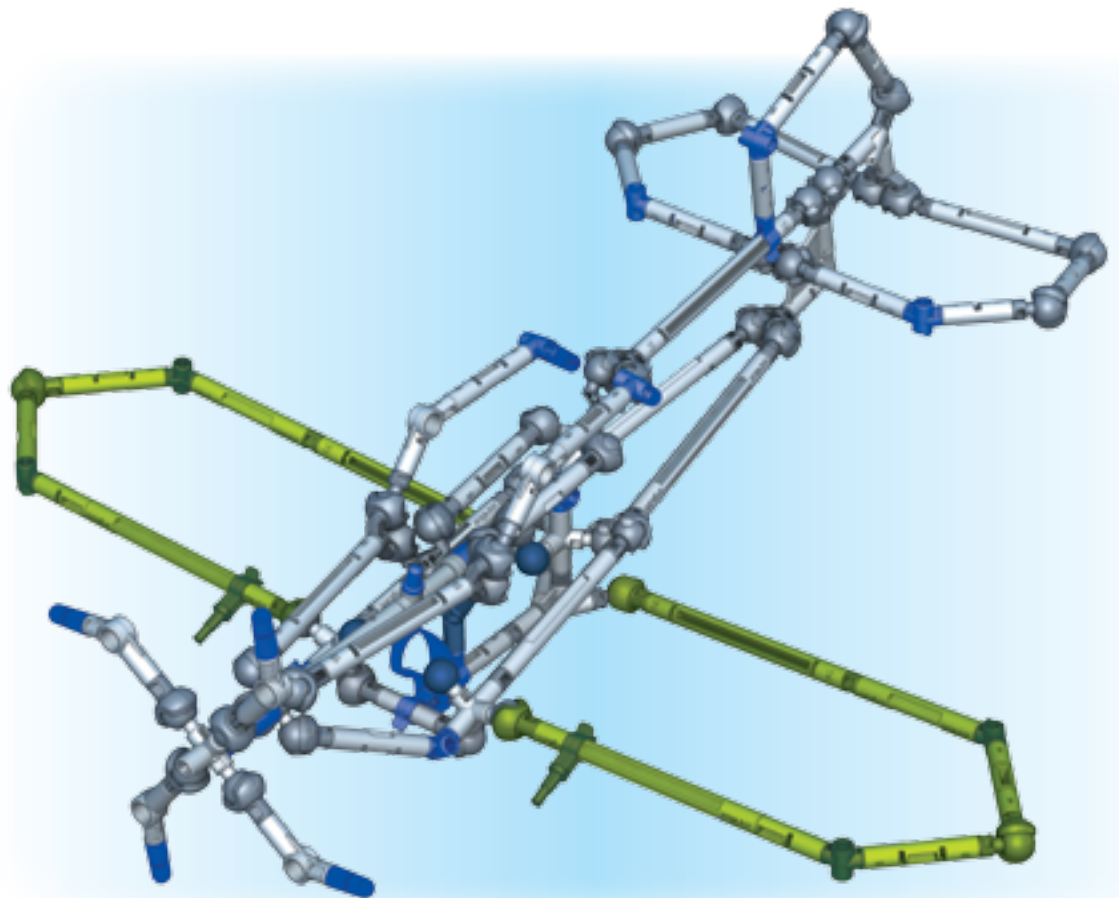
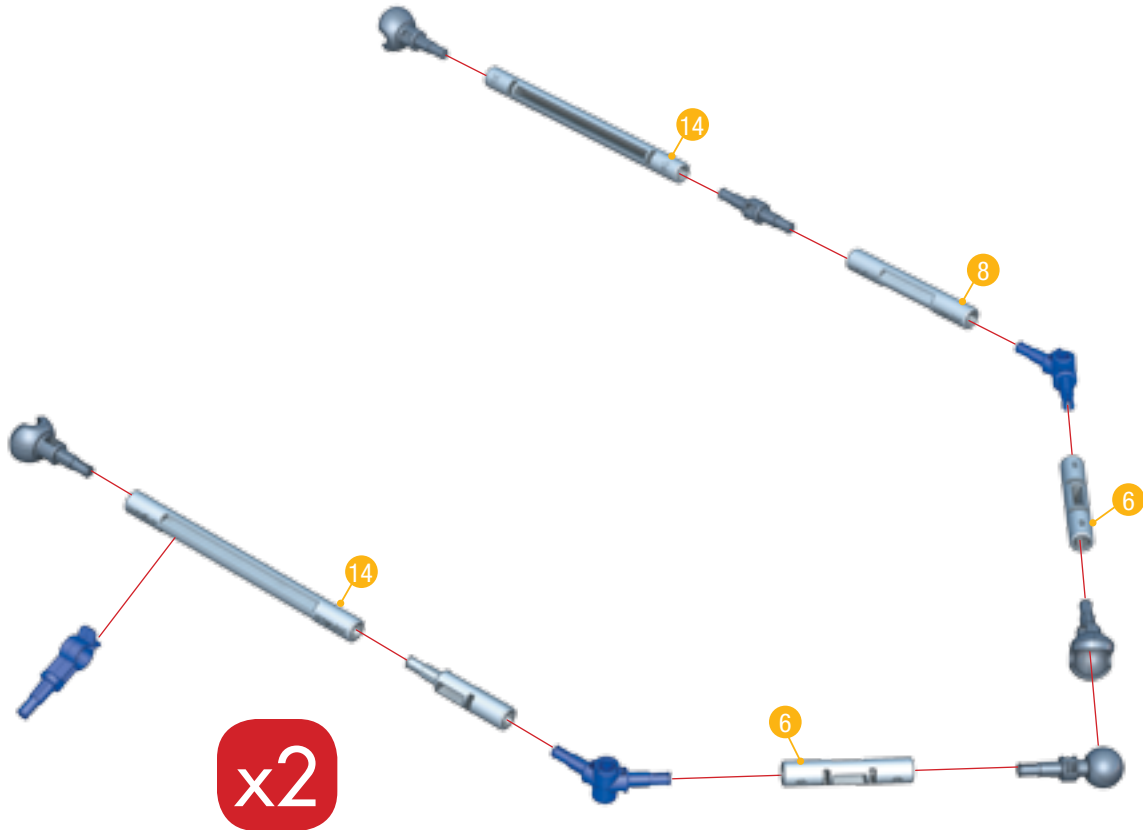
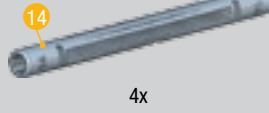
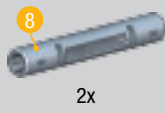

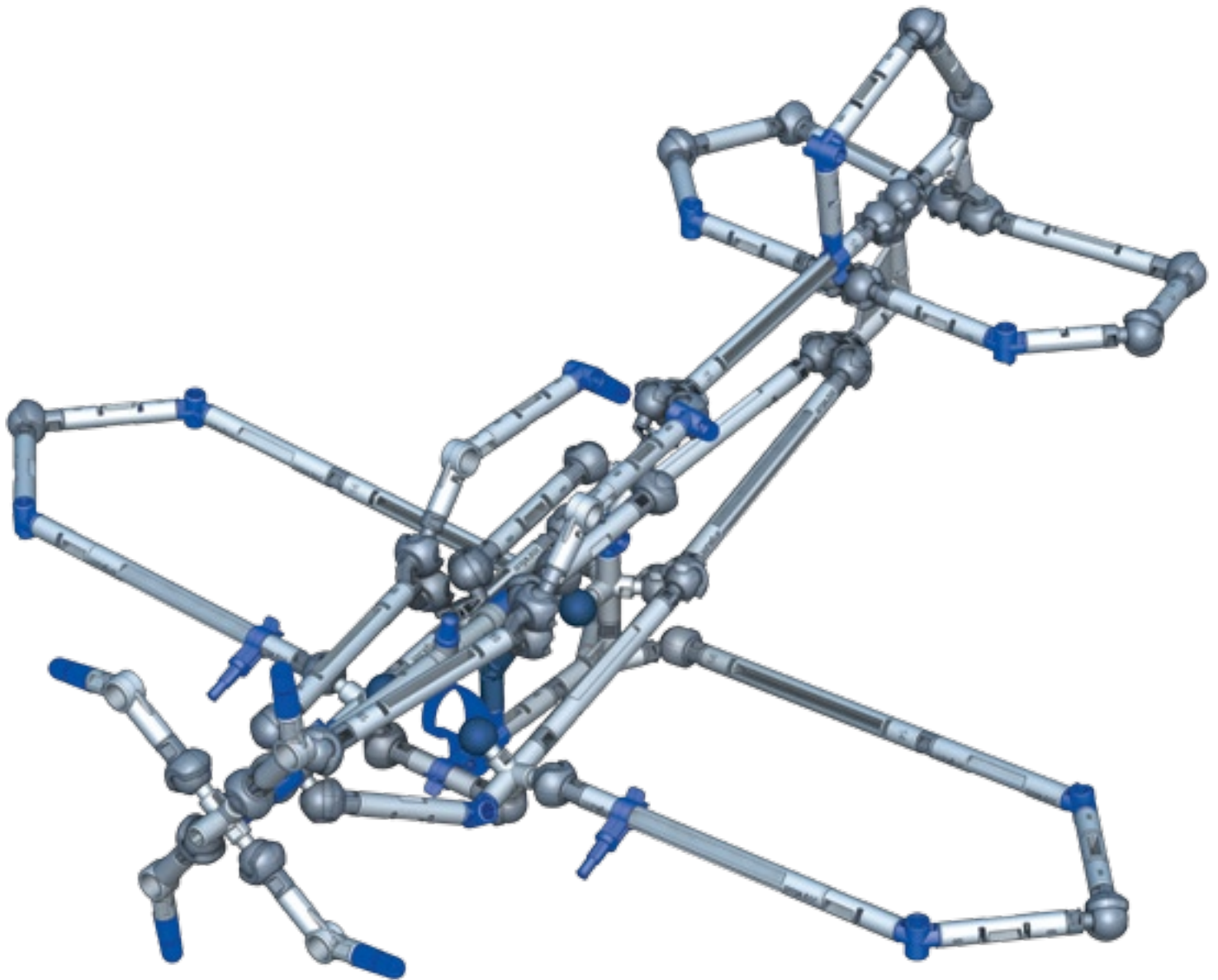

Let's Play! / ¡Juguemos! / Allons jouer! / Viel Spaß beim Spielen! / Laten we spelen! / Giochiamo! / Vamos brincar!

1

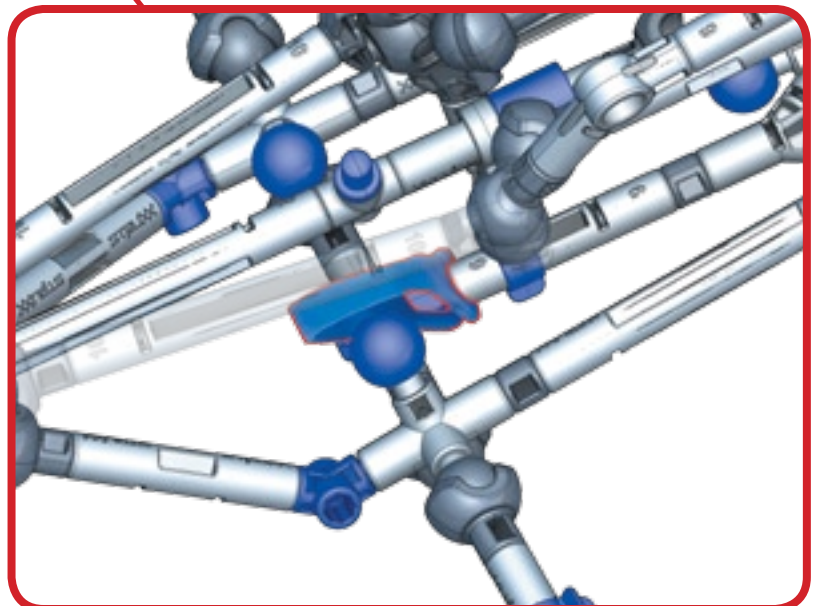
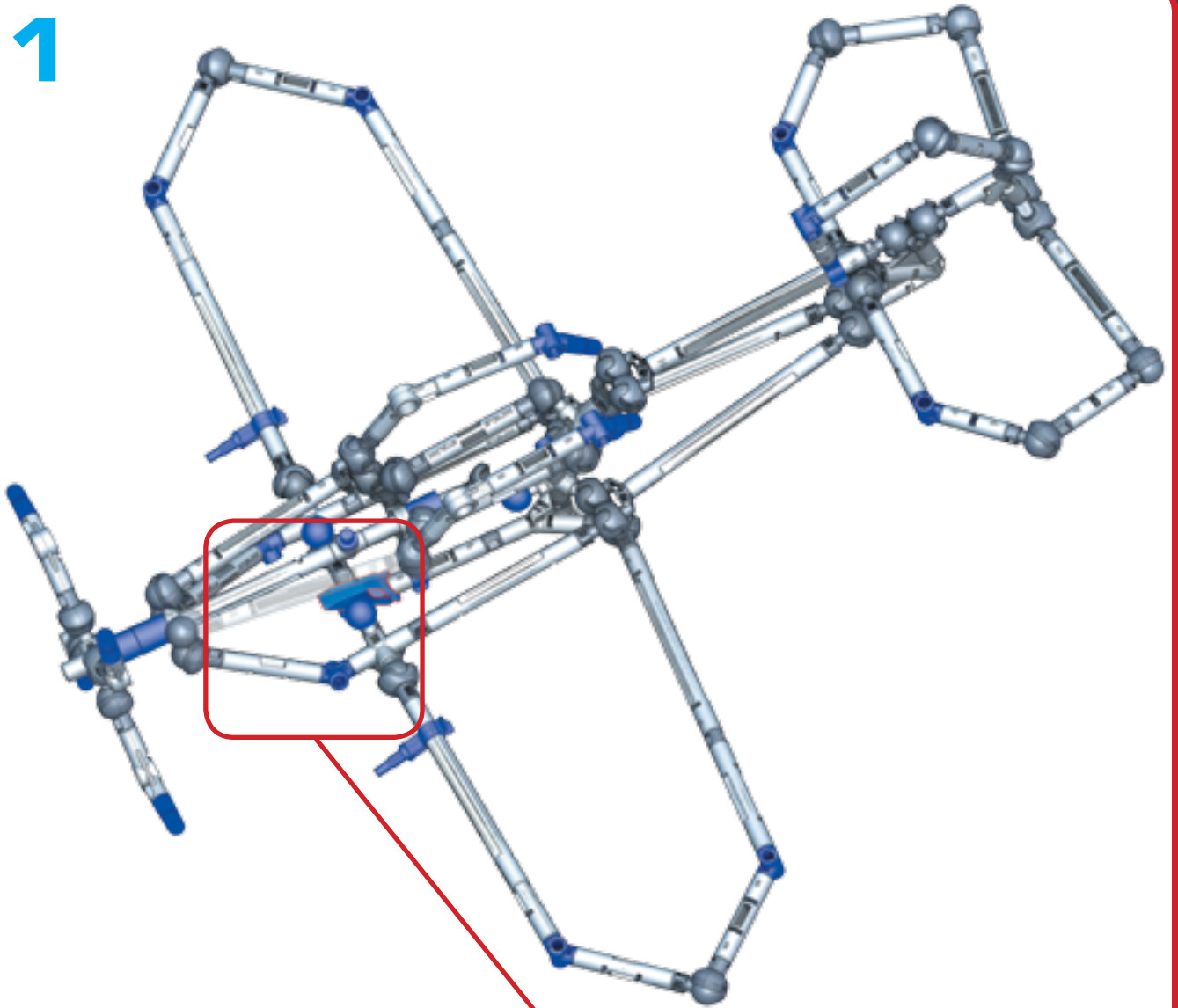

2

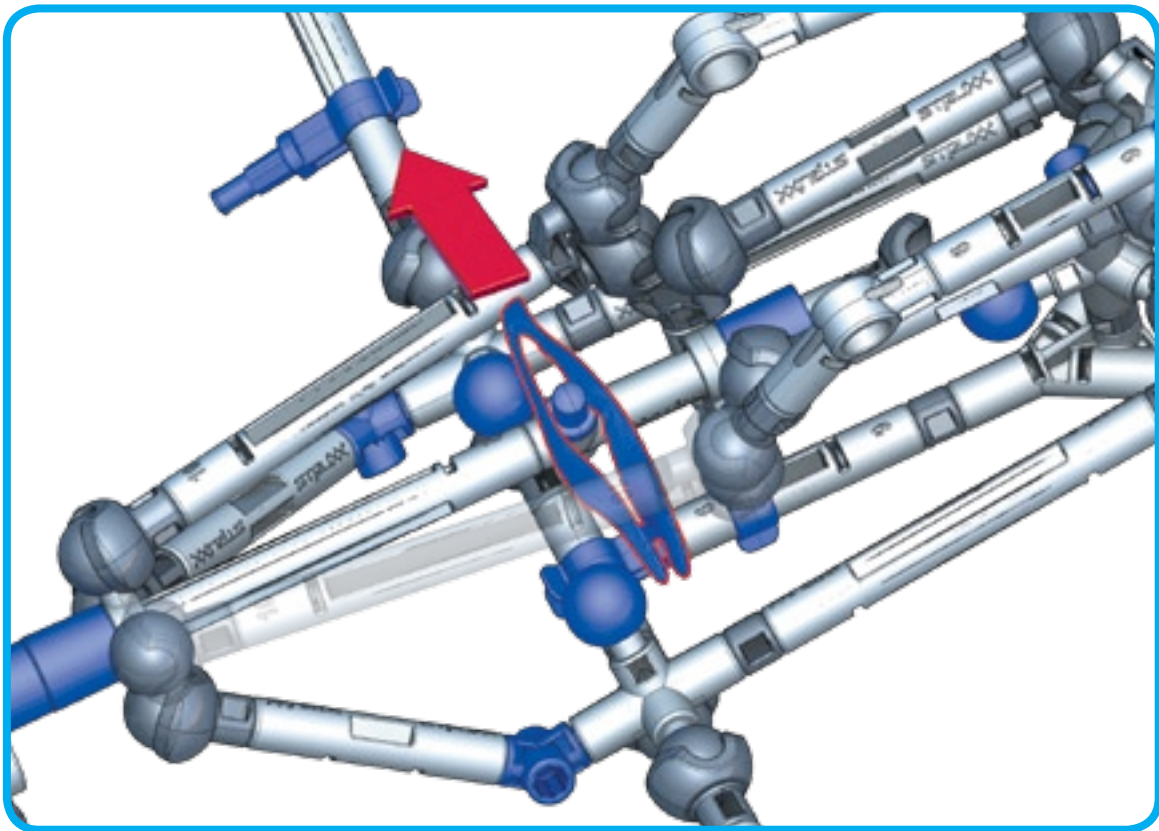

3

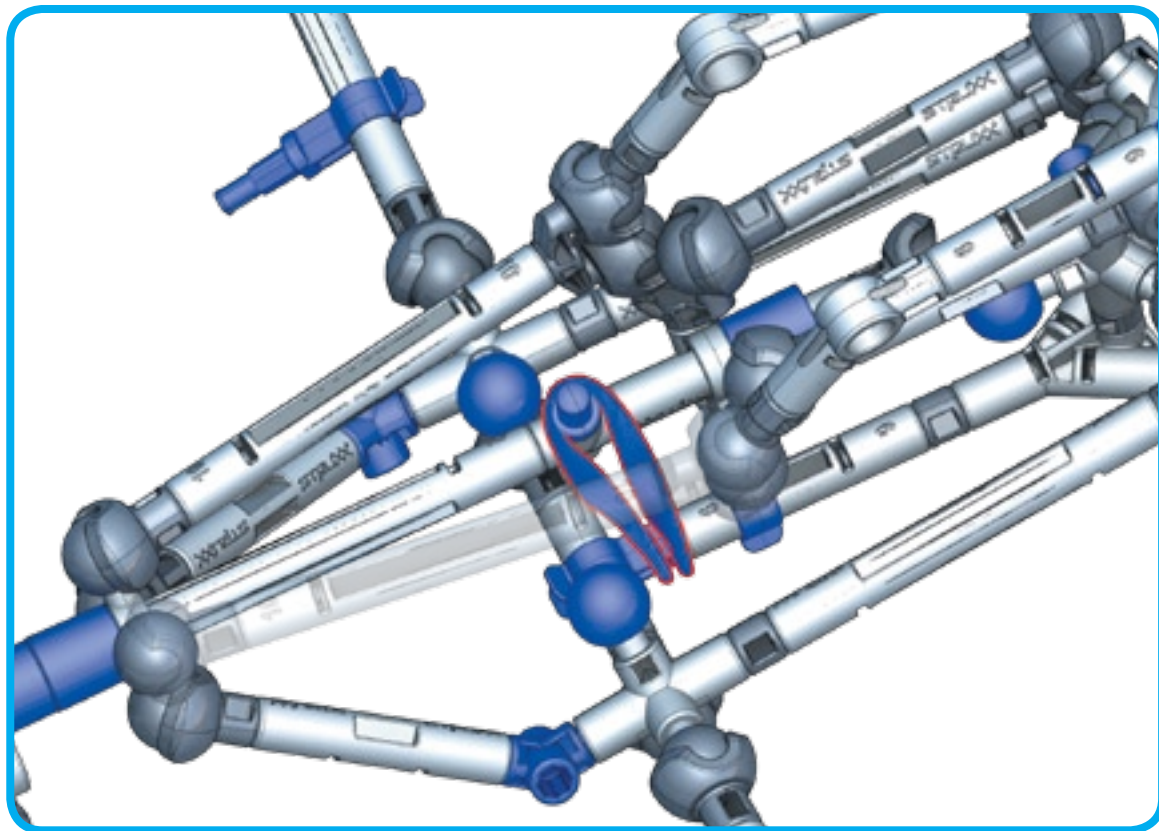

4

To activate propeller turn red highlighted parts / Para activar la hélice, gira las piezas rojas / Tourne les pièces indiquées en rouge pour mettre l'hélice en marche / Drehe die rot unterlegten Teile, um den Propeller zu aktivieren / Draai aan de in het rood weergegeven onderdelen om de propeller te activeren / Per azionare l'elica, fai ruotare le parti evidenziate in rosso / Para activar a hélice, roda as peças realçadas a vermelho

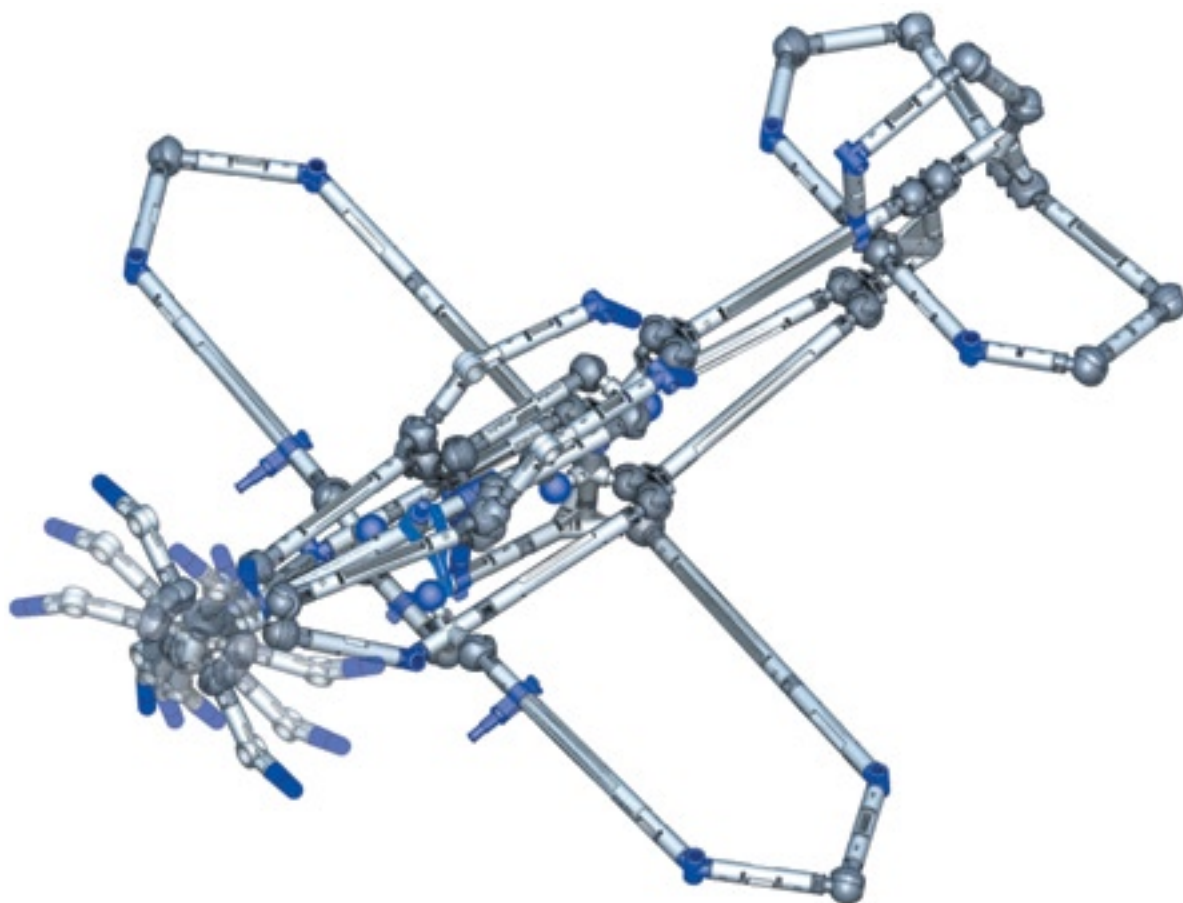
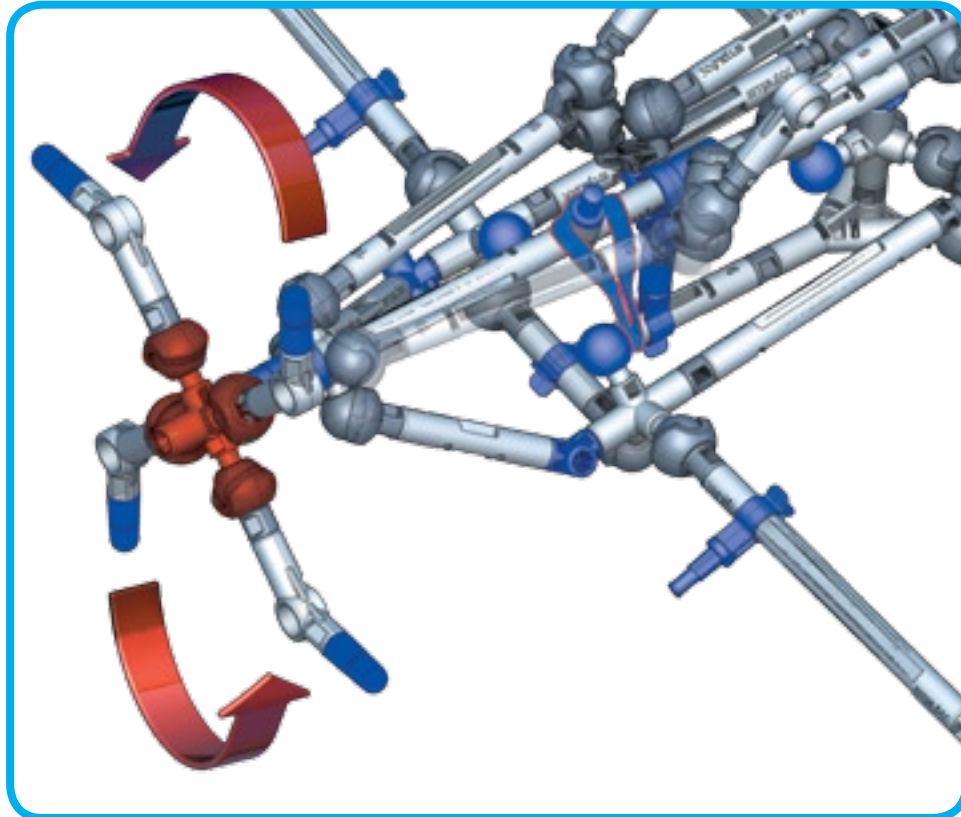

**Build / Construir / Construire / Bauen /
Bouw / Costruisci / Construir**

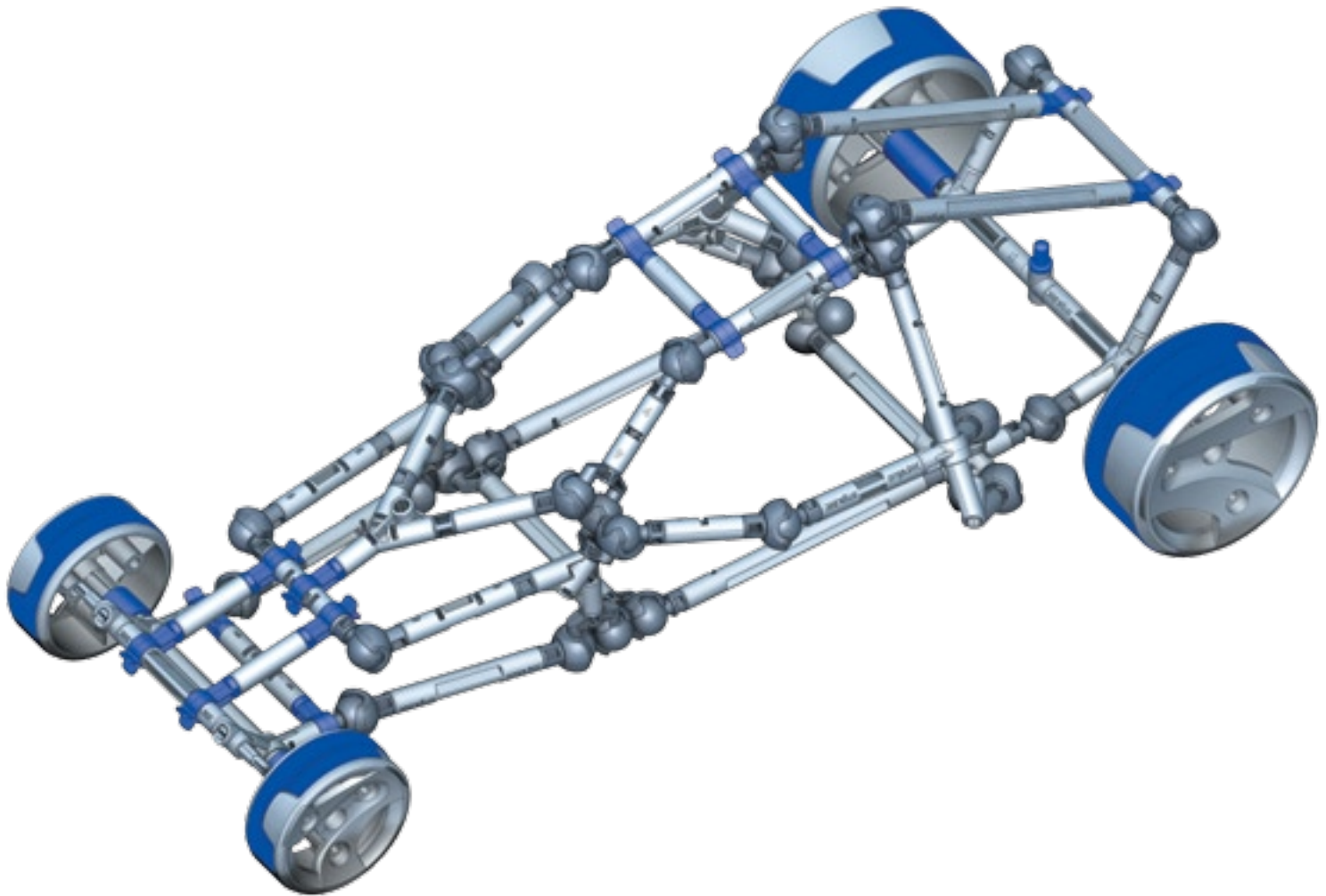

1

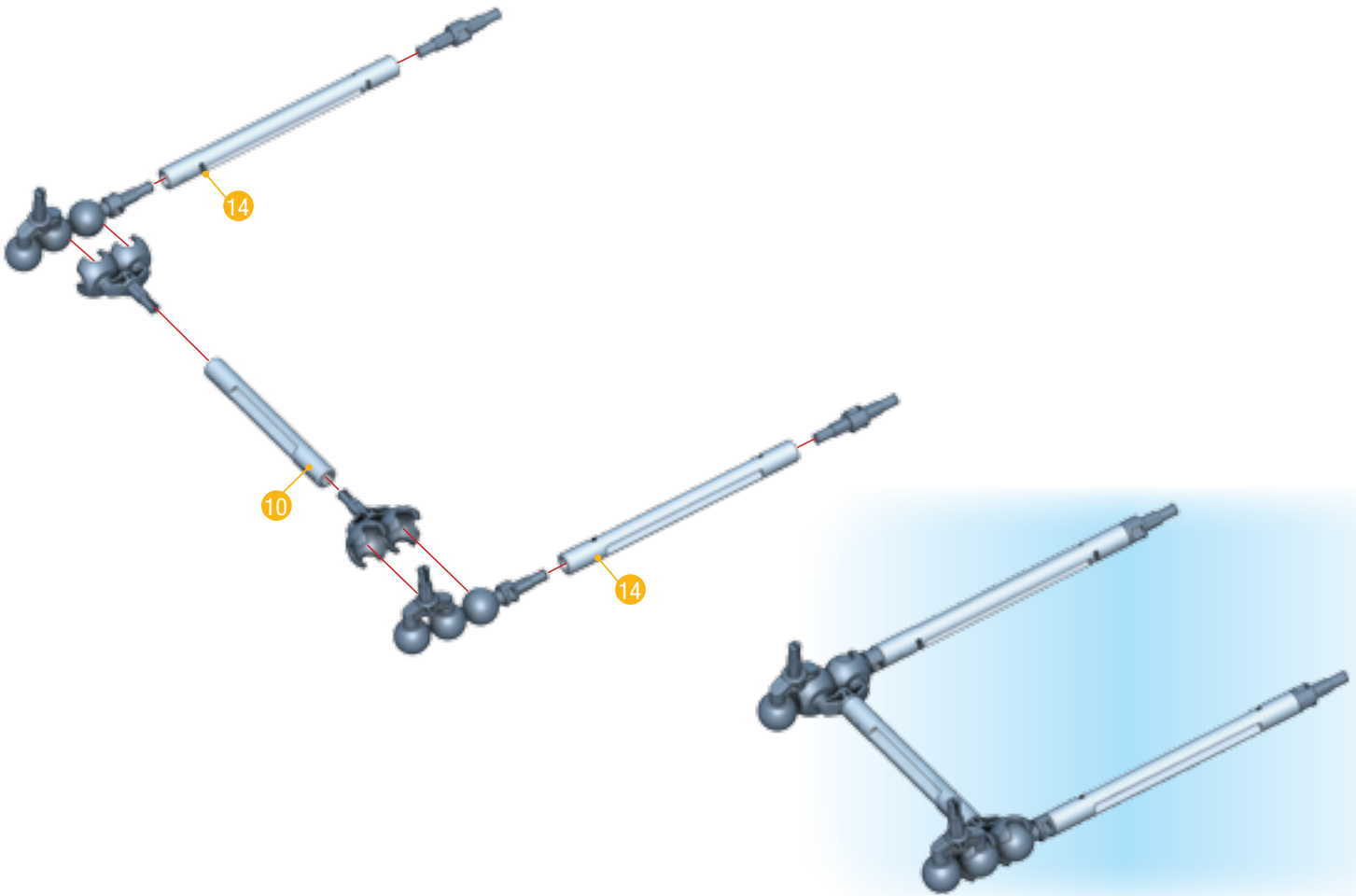

2

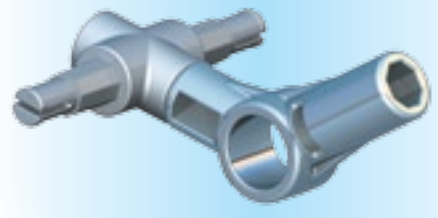
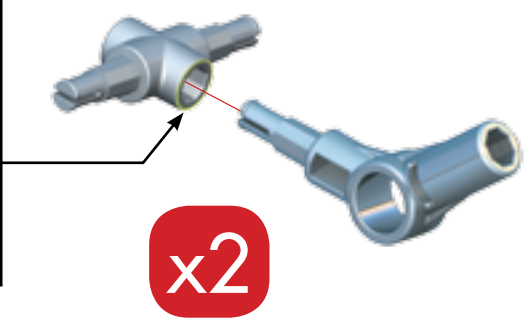
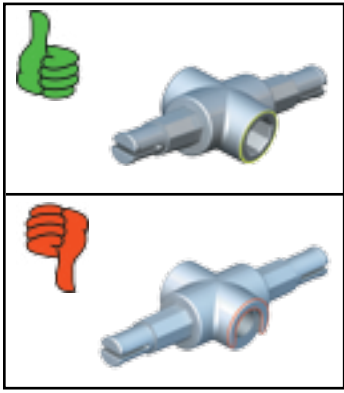
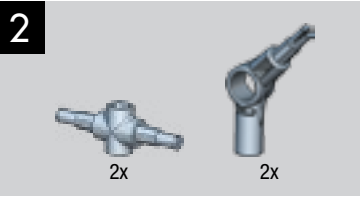

3

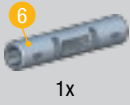

1x



3x



2x



4x



2x

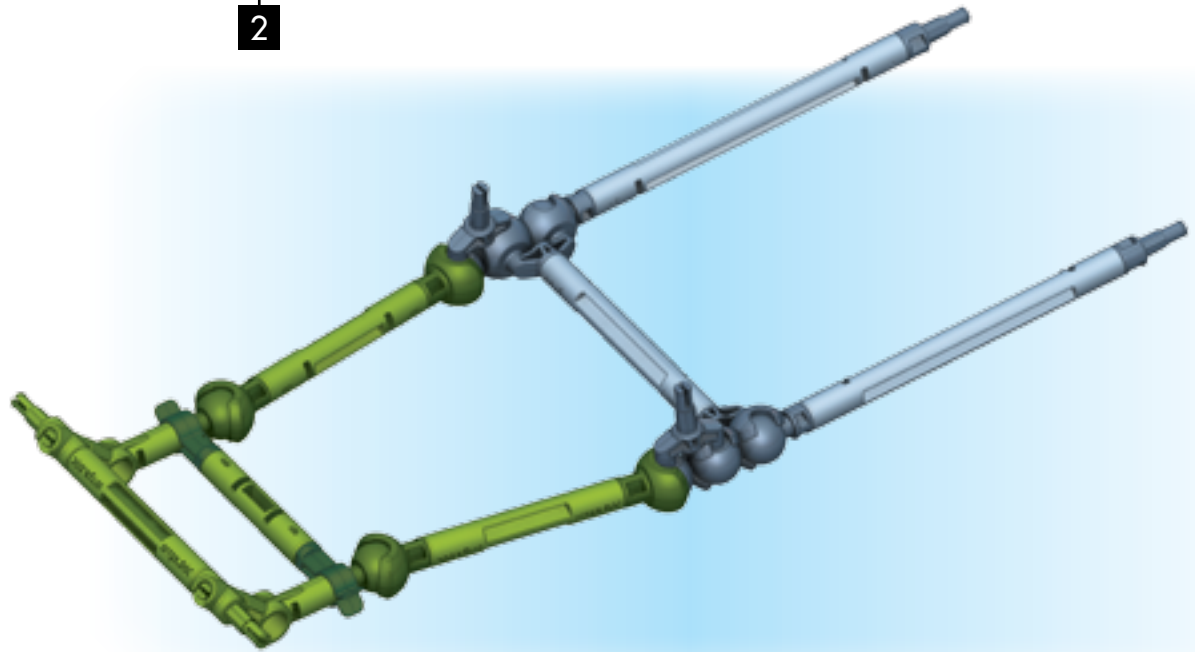
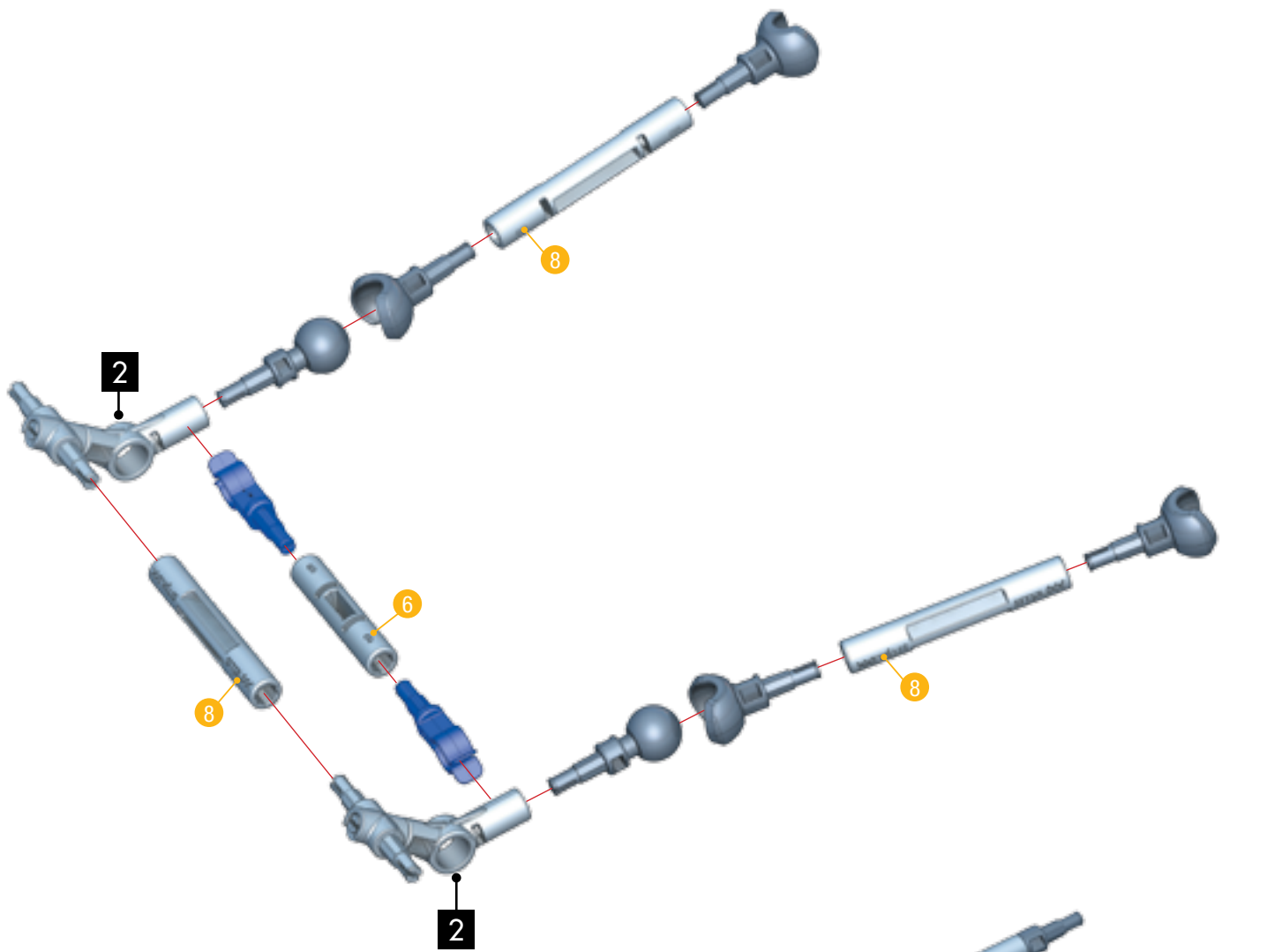

4

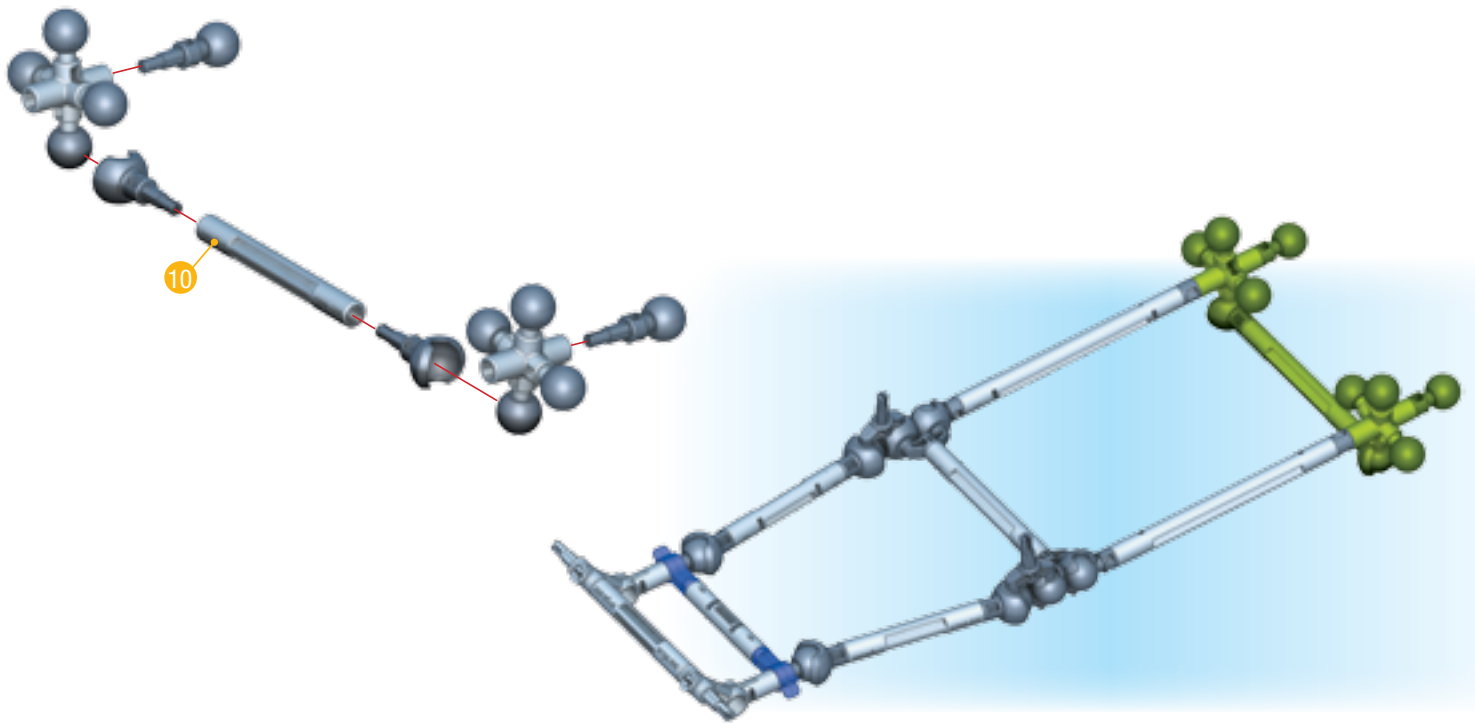

5

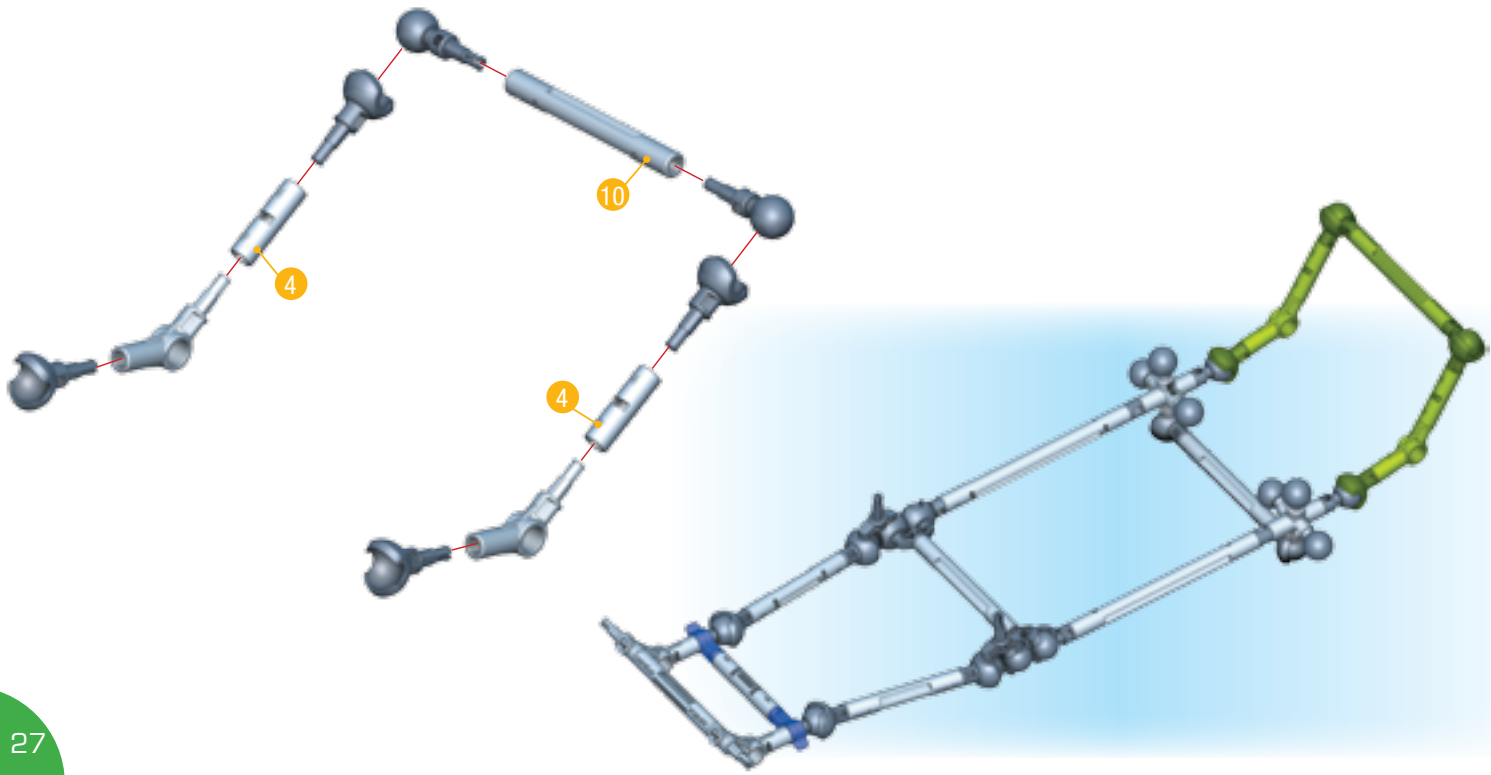
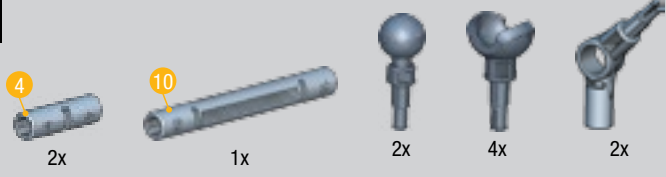

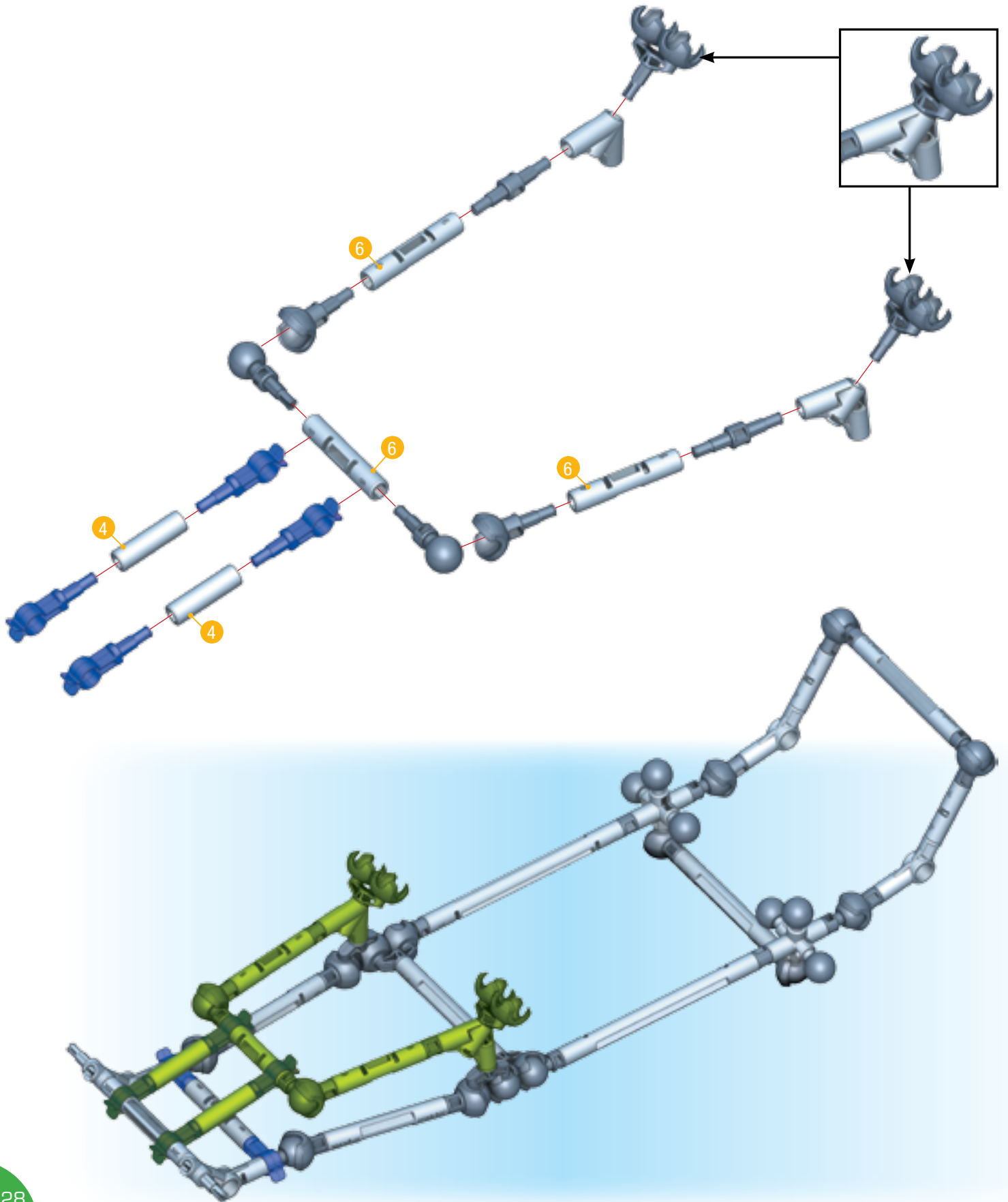
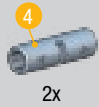

8

4



2x



2x



2x

x2

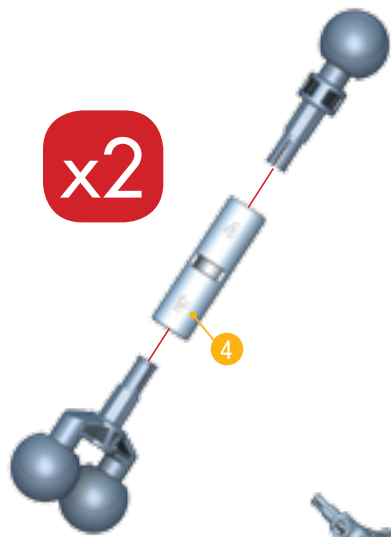

4

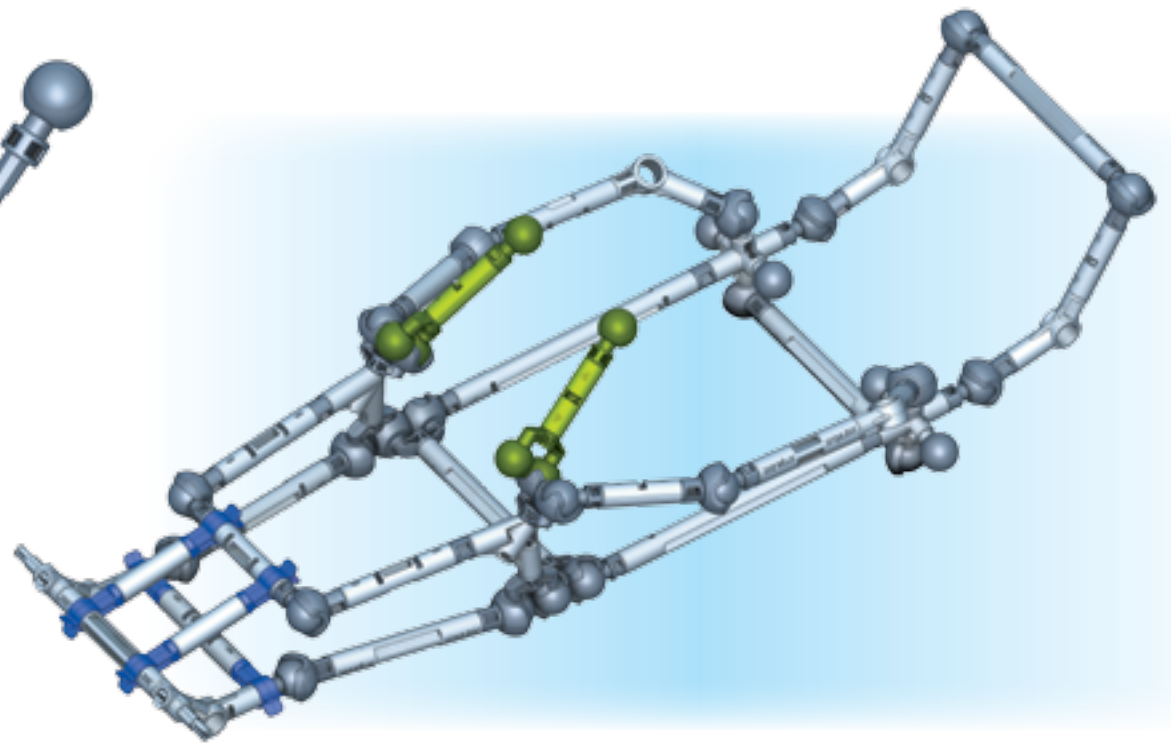

9

8



2x



2x



2x



2x

x2

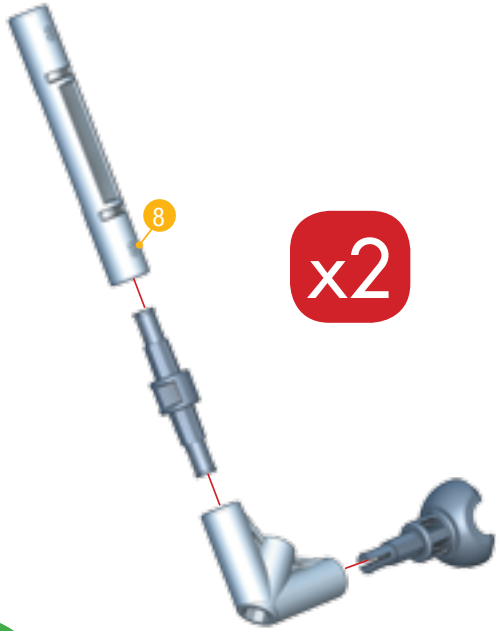

8

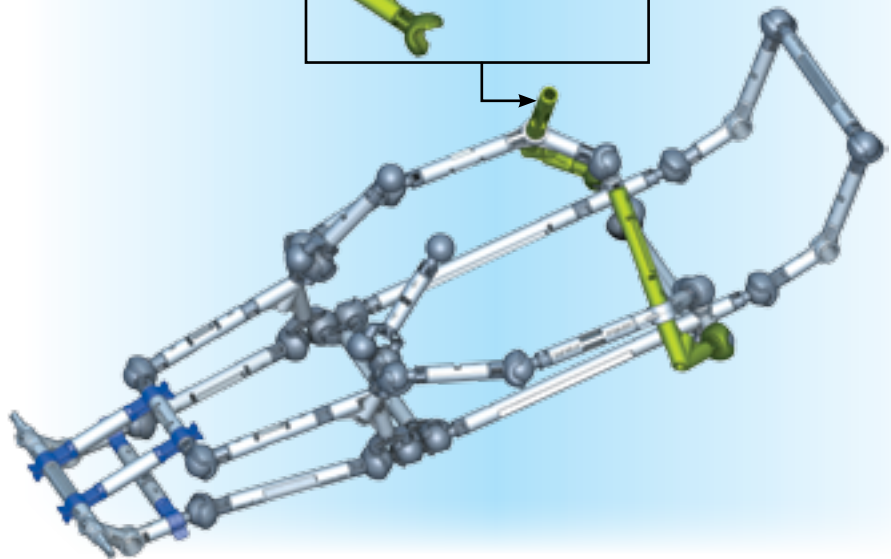
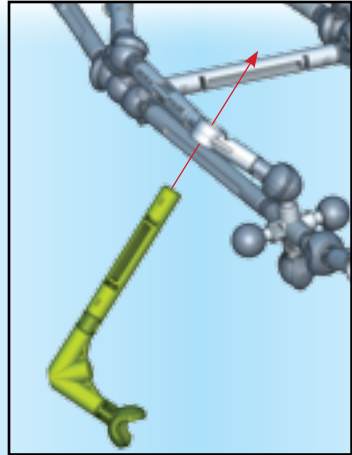

10



2x



2x



1x



2x



1x

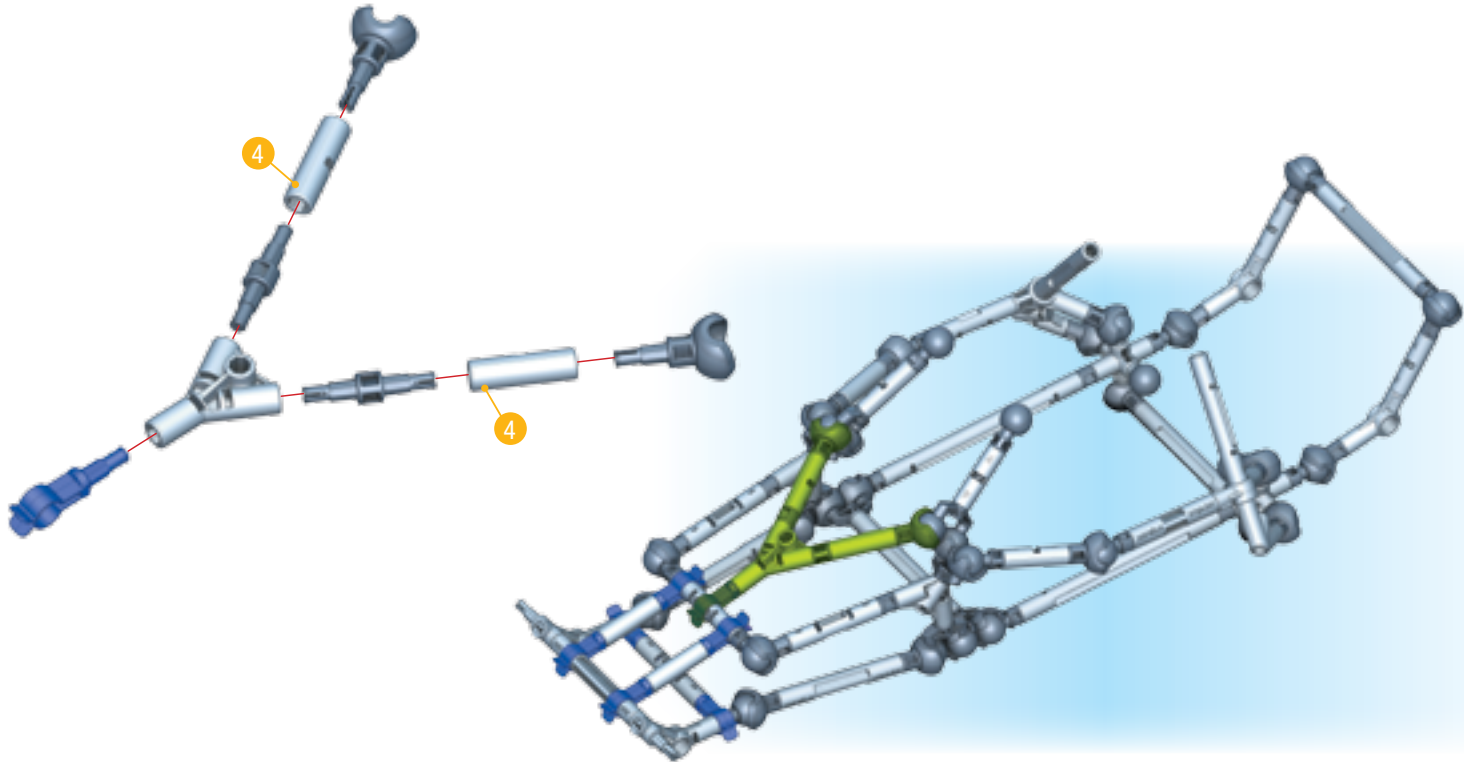

11



2x



2x



2x



2x

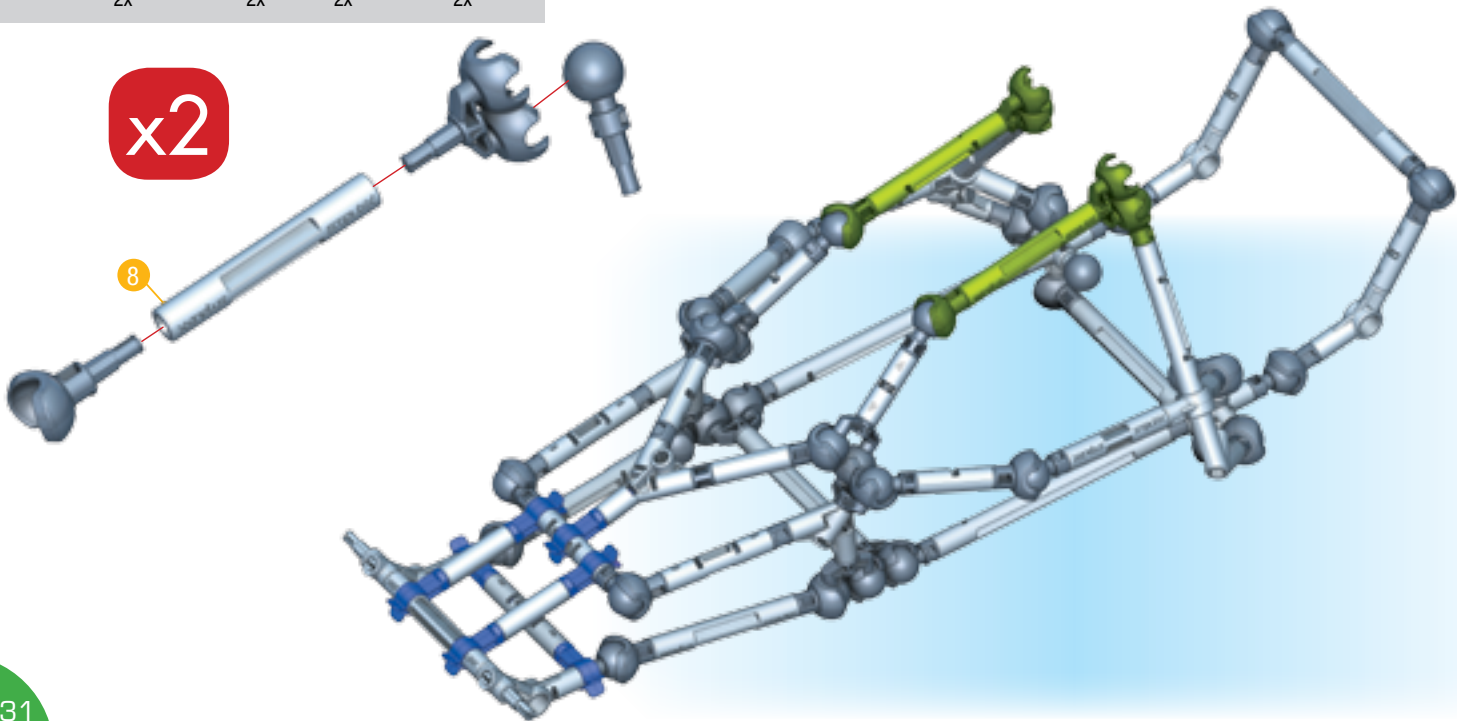

12

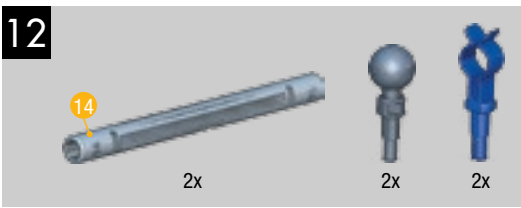

x2

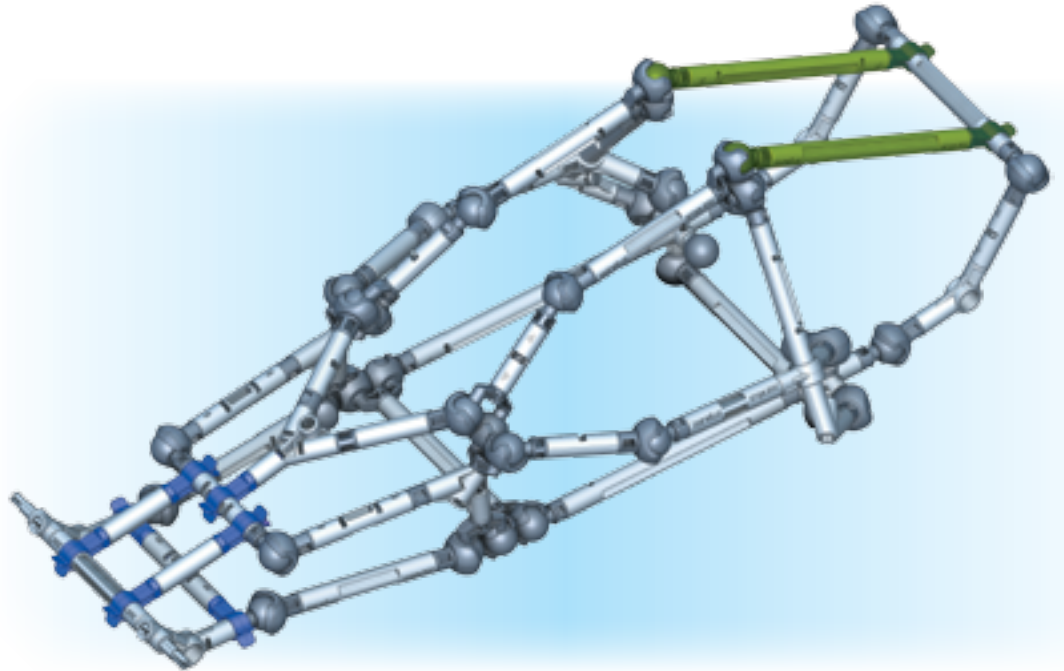

13

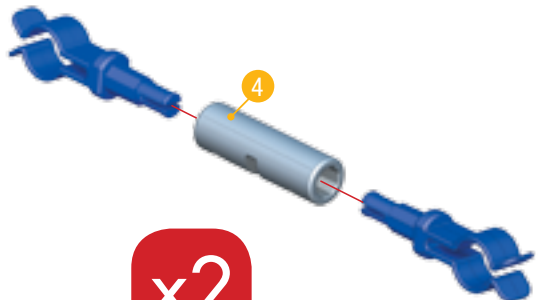

x2

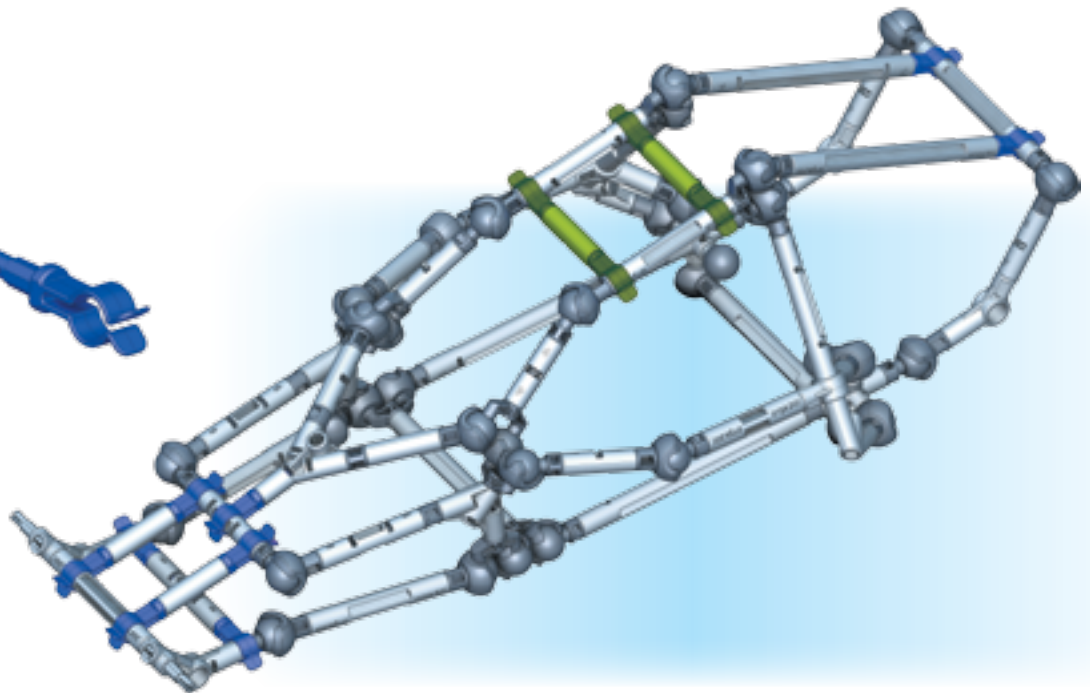

14

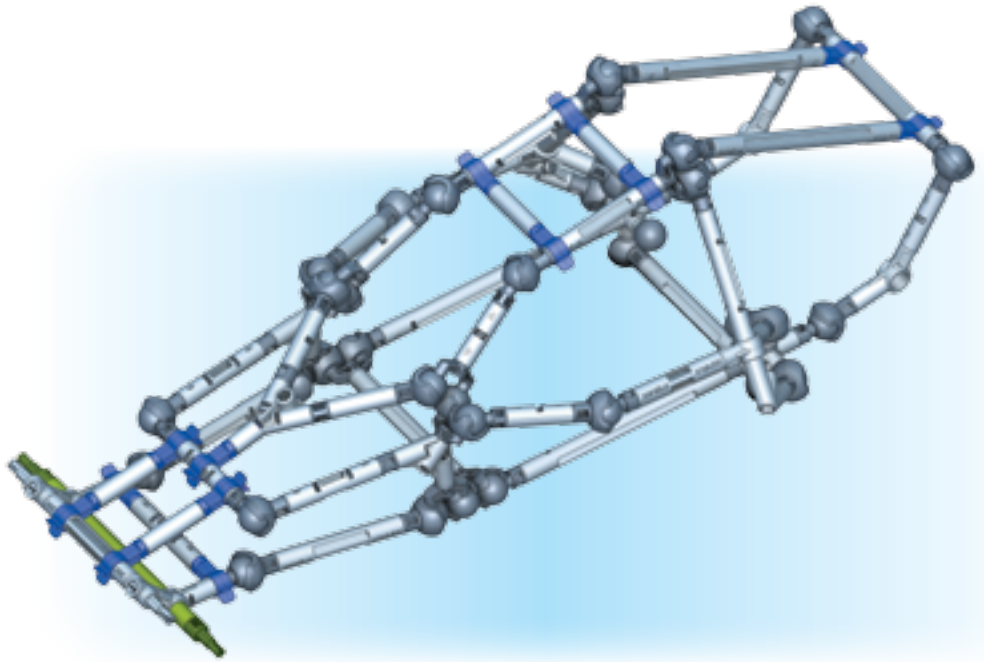

15

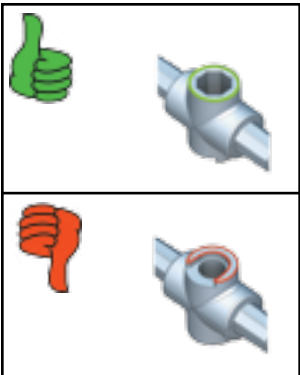
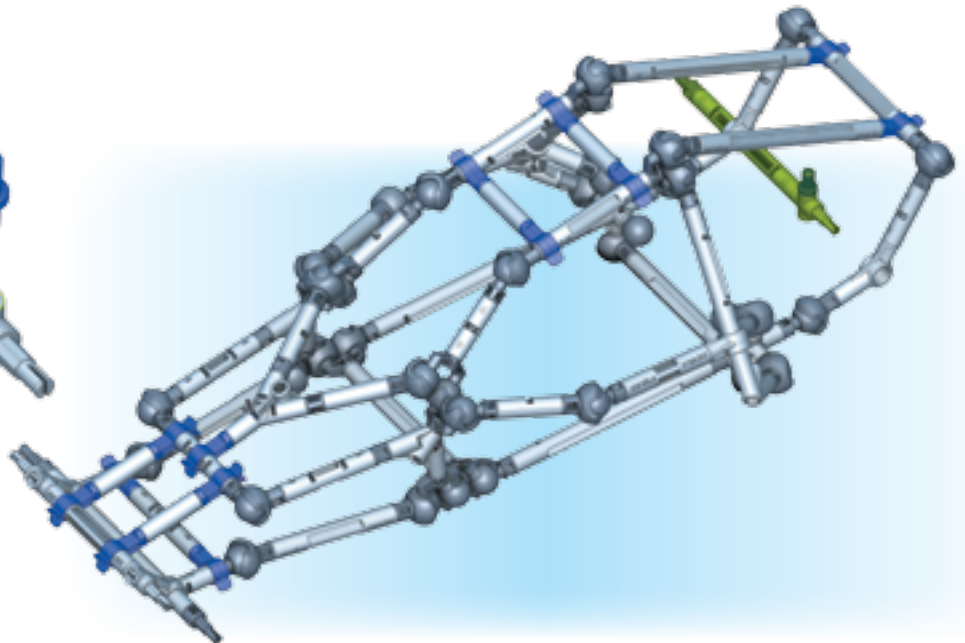
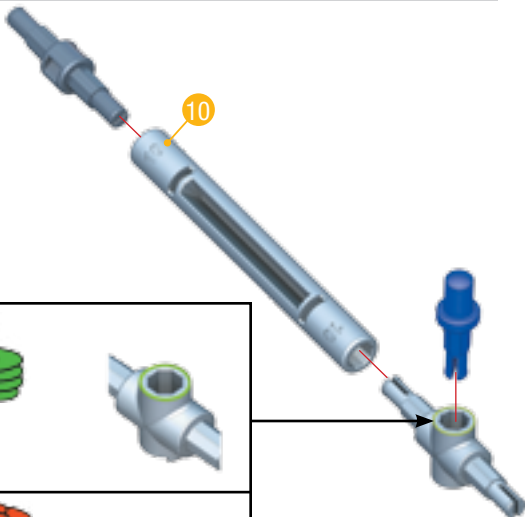
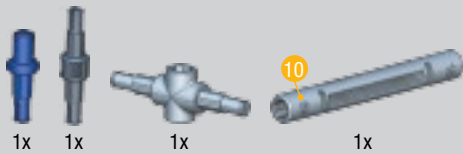

16



1x



1x



2x

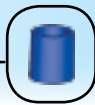

17



4x

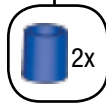

18

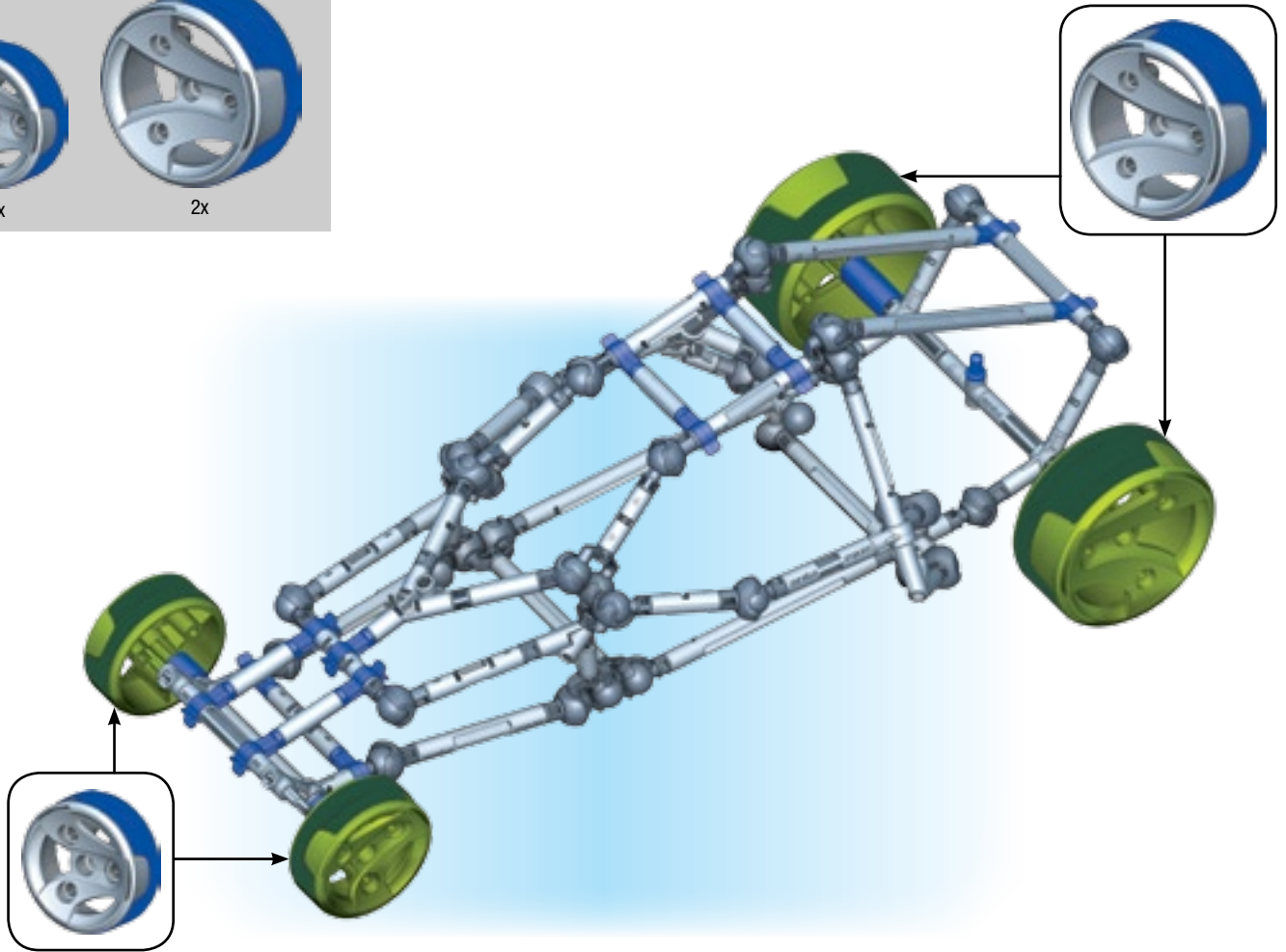
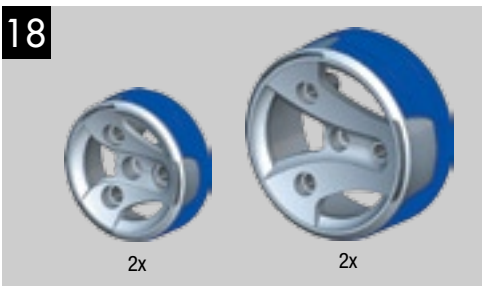

19

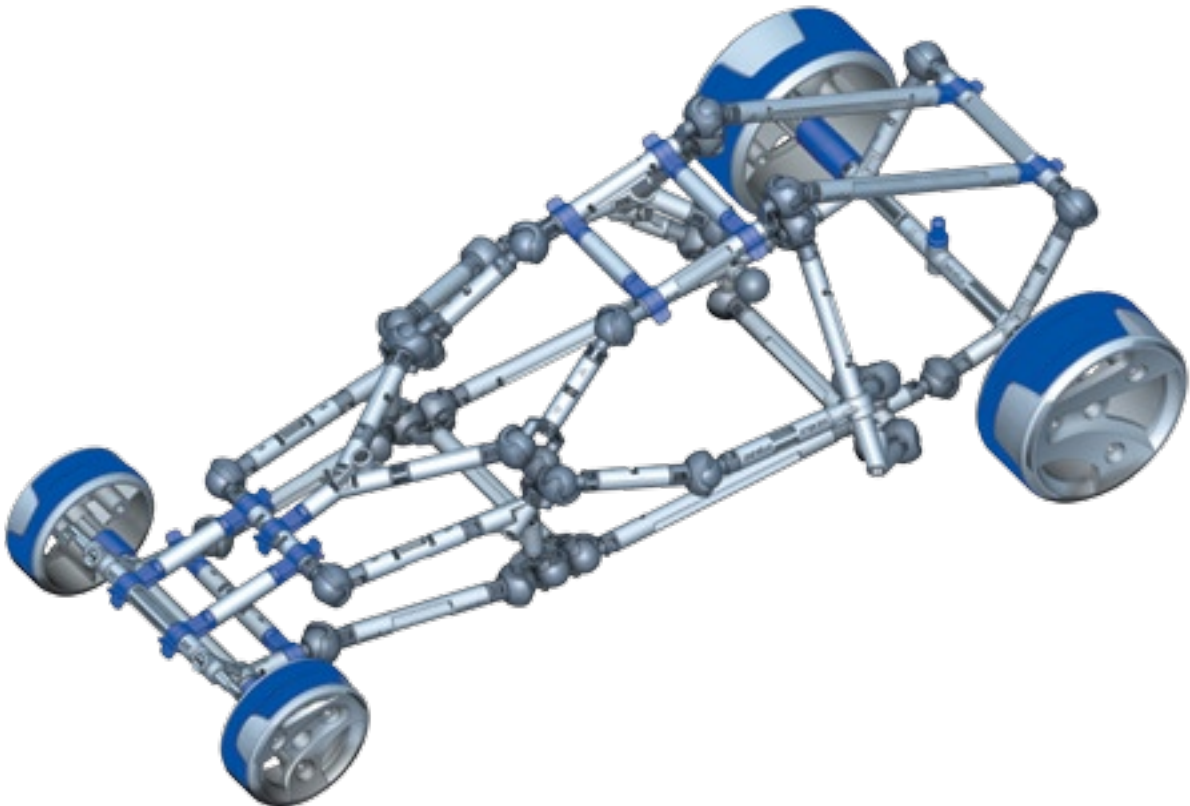

Let's Play! / ¡Juguemos! / Allons jouer! / Viel Spaß beim Spielen! / Laten we spelen! / Giochiamo! / Vamos brincar!

1

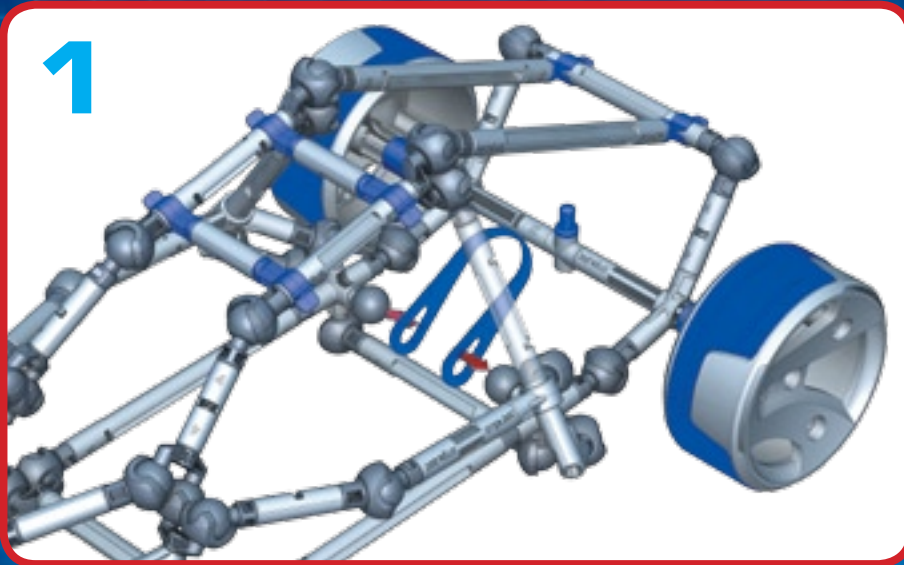

2

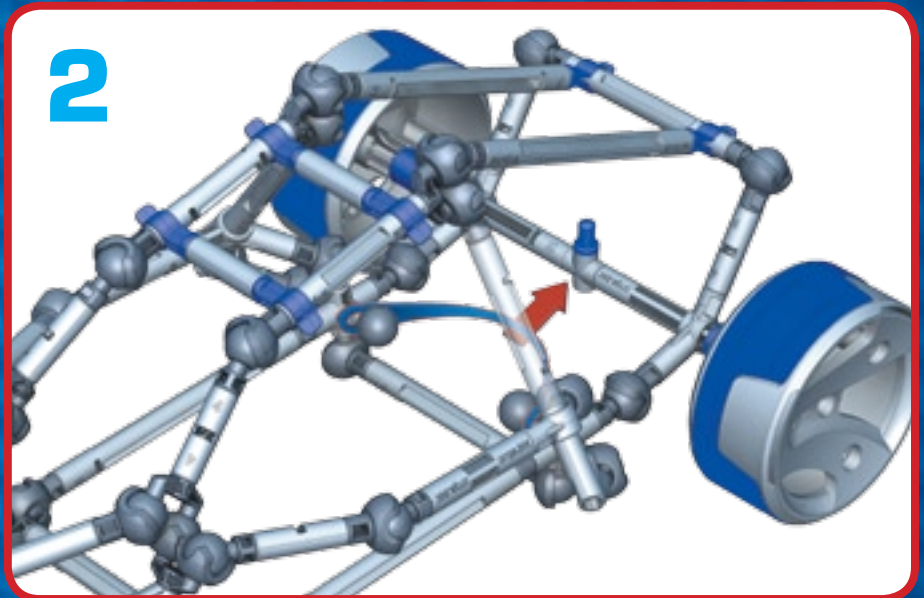

3

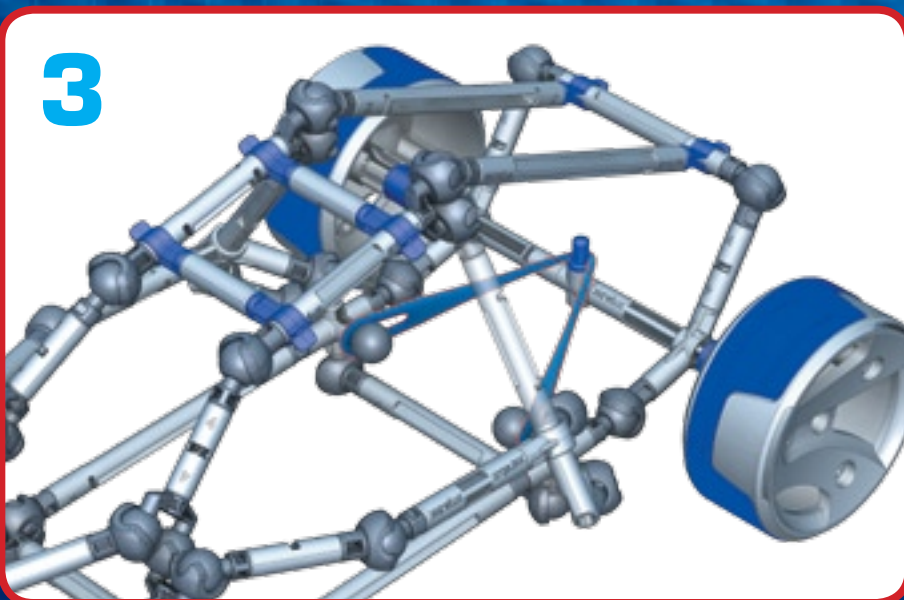

4

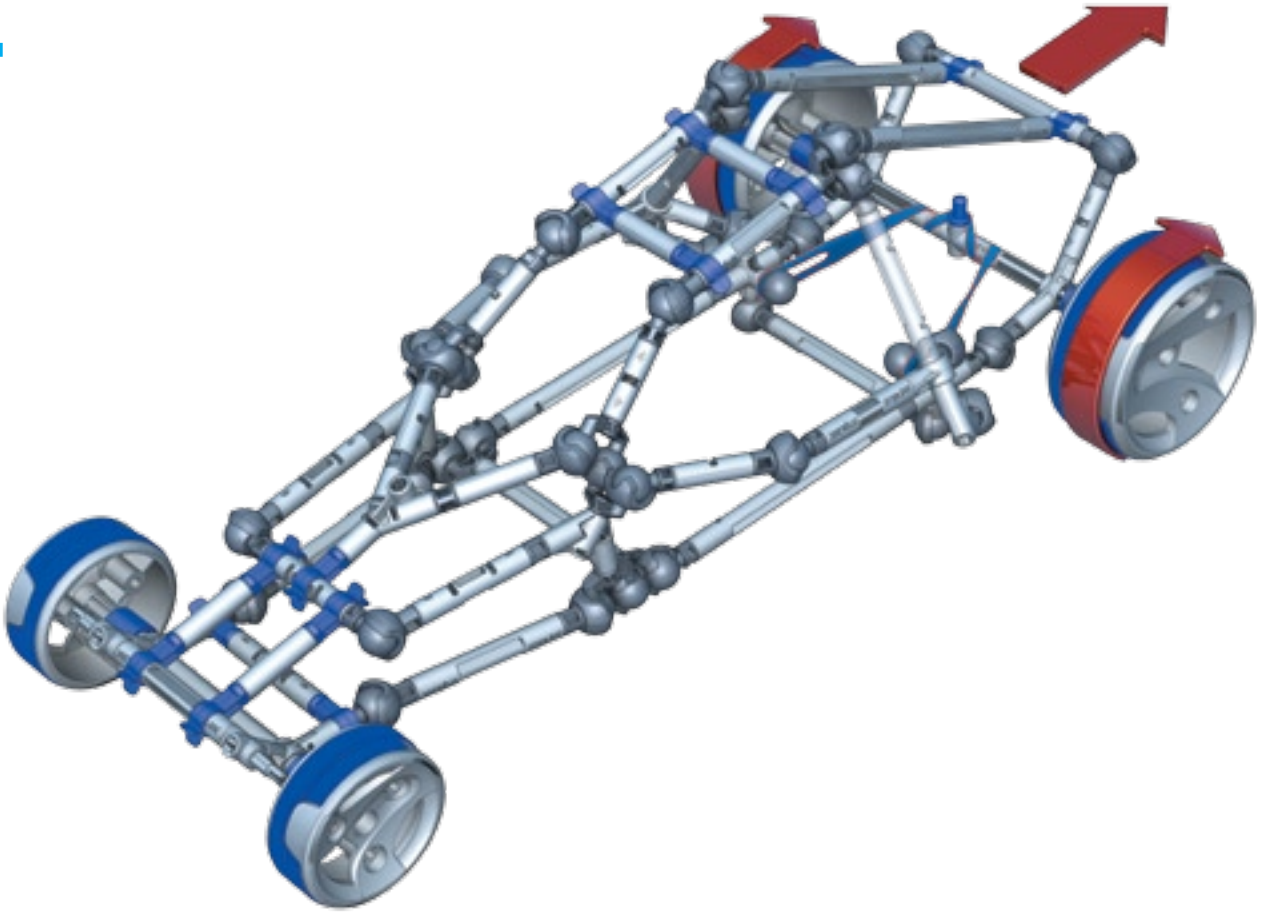

5

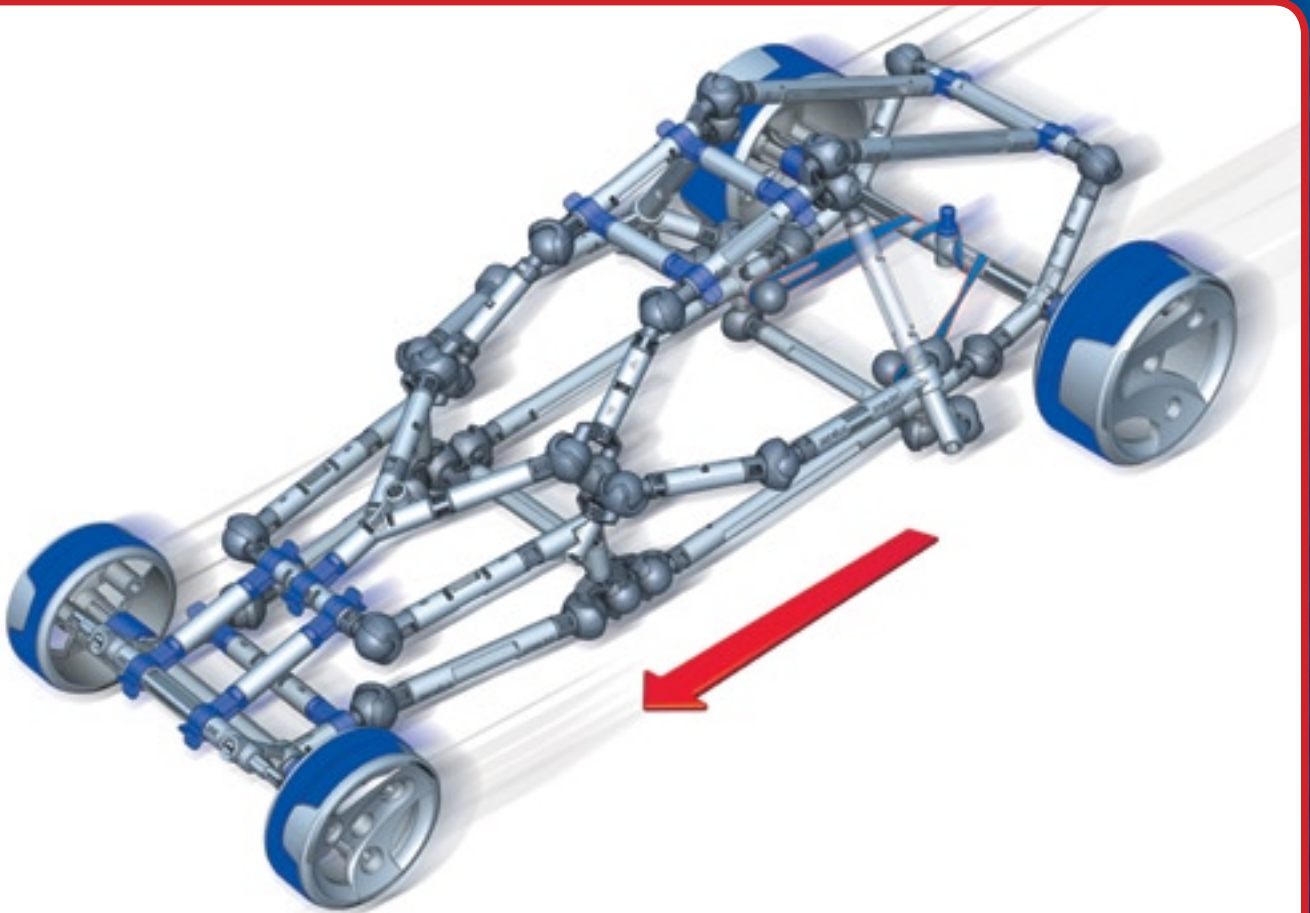



SIZE IT UP!



www.struXXworld.com

For exclusive StruXX™ assembly instructions and other bonus features go to www.StruXXworld.com / Si deseas consultar las instrucciones detalladas del montaje de StruXX™ u otra información adicional, visita www.StruXXworld.com / En exclusivité, des instructions de montage StruXX™ et d'autres caractéristiques sont à découvrir sur www.StruXXworld.com / Exklusive Bauanleitungen für StruXX™ sowie weitere Extras findest du unter www.StruXXworld.com / Ga naar www.StruXXworld.com voor exclusieve StruXX™ - bouw instructies en andere bonusfeatures. / Per esclusive istruzioni di assemblaggio relative ai StruXX™ e altre funzioni bonus, visita www.StruXXworld.com / Para obter instruções para a construção de StruXX™ e aceder a outras opções extra, visitar www.StruXXworld.com

STRUXX

SIZE IT UP!

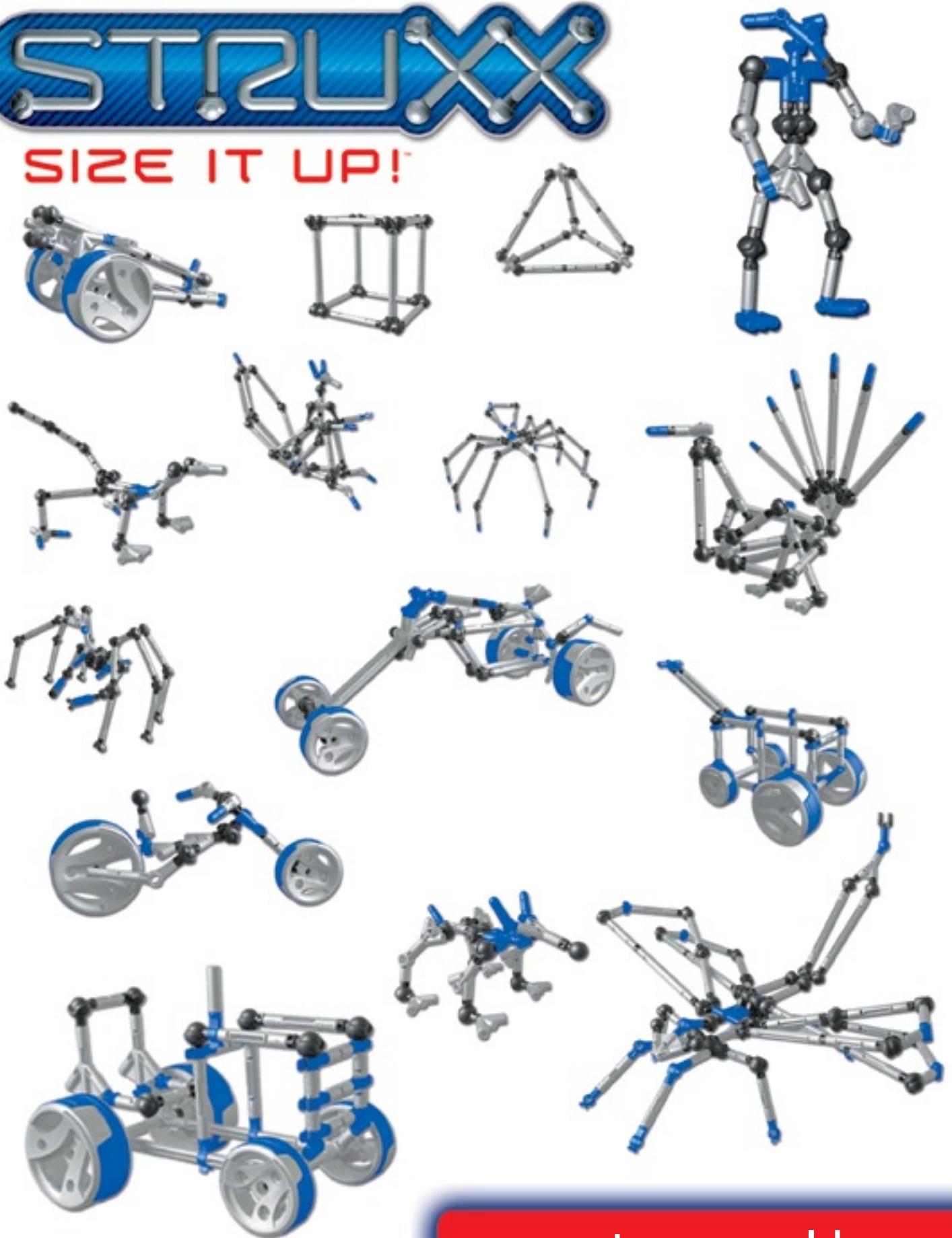

www.struxxworld.com

BUILDING IDEAS / IDEAS DE CONSTRUCCIÓN / IDÉES DE CONSTRUCTION / BAUVORSCHLÄGE /
BOUW SUGGESTIES / IDEE DI COSTRUZIONE / IDEIAS DE CONSTRUÇÃO

STRUXX

SIZE IT UP!

Also available
Tambien disponible
Également disponible
Ebenfalls erhältlich
Eveneens beschikbaar
Anche disponibile
Tambem disponível



6000
Basixx 40x™



6001
Robotrixx™



www.struxxworld.com

