



**MEGA
BLOKS**

2005

Final Battle™

6+

325 PCS™

SPIDER-MAN 3

Construction Toy / Juguete de construcción / Jeu de construction /
Konstruktionsspielzeug / Bouwspelgoed / Gioco di costruzioni / Brinquedo de construção

4x AM11132ZD
 9x AM1113DR
 5x AM1113F
 4x AM1113TS
 2x AM01683KJ
 2x AM03328X
 2x AM03328Z
 3x AM1312E
 5x AM1312KJ
 2x AM1312TS
 2x M12251KJ
 4x M12251F
 4x AM0910TS
 4x AM04428KJ
 4x AM04428MM
 1x M022501KJ

3x M1137MM
 2x M1137KJ
 1x AM1295TS
 1x AM1294TS
 1x AM1276TS
 2x AM1296TS
 1x AM02172GZ
 4x AM07629RF
 3x AM09393RF
 2x AM09393XV
 3x AM09393F

2x M022501WD
 6x AM09198KJ
 1x M022501JG
 2x AM25120GZ
 4x AM03019RF
 5x AM09013XV
 7x AM09013RF
 2x M1133KJ
 2x AM01417TS
 2x AM07923MM
 2x AM07923F
 2x AM04245MM
 1x AM04245XV

2x AM04217XV
 3x M0948JG
 4x M0948MM
 2x AM25120GZ
 4x AM03019RF
 5x AM09013XV
 7x AM09013RF
 2x M1133KJ
 2x AM01417TS
 2x AM07923MM
 2x AM07923F
 2x AM04245MM
 1x AM04245XV

1x AM04248XV
 3x AM25114GZ
 4x AM1314F
 2x AM1314DH
 6x AM04247XV
 2x AM01418TS
 1x AM09593MM
 2x AM09593F
 2x AM09593JG
 6x AM09593TS
 2x M1389JG

1x AM01847KJ
 4x AM01847LA
 2x M1390JG
 1x AM1142LW
 1x AM1142MM
 1x AM04249XV
 2x AM1087XV
 1x AM1087RF
 1x AM07630RF
 1x AM09493JG
 2x AM09493XV

6x AM09493TS
 1x AM09493F
 4x AM0933RF
 2x AM03058JG
 1x AM03058RF
 1x AM1313F
 3x AM1313RF
 2x AM1313XV
 2x AM1480JG
 2x AM09204RF

2x M1123KJ
 3x AM03514GZ
 2x AM03514XV
 2x AM03514KJ
 2x AM09241TS
 1x AM09243TS
 1x AS0200507
 4x AM09239VW
 1x AM07013W

4x M1147MM
 4x AM09197LW
 26x AM09238LA
 1x AM06192LW
 1x AM07010MY
 1x AM07010F
 6x AS0200502

2x AM09242TS
 4x AM06618MM
 1x S1163JG
 2x AM09033JG
 1x AM06974MY
 1x AM06926MY
 8x AM04983JG
 1x AM09248KJ

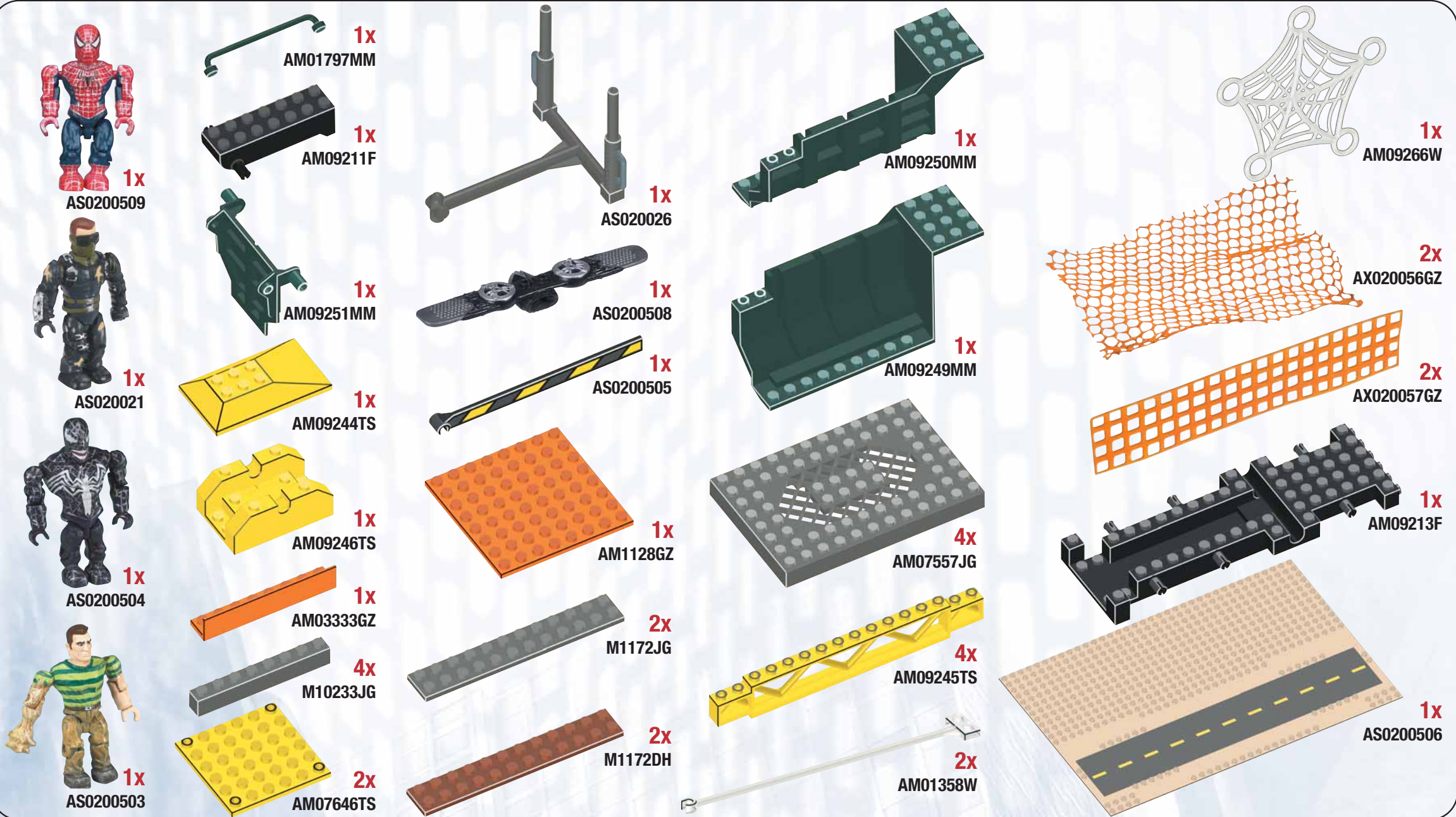

Please read these instructions carefully before first use and keep them for future reference. / Leer estas instrucciones cuidadosamente antes de la primera utilización y guardarlas para referencia futura. / Il est recommandé de lire attentivement ce feuillet avant la première utilisation et de le conserver pour référence future. / Die Gebrauchsanleitung bitte durchlesen und aufbewahren. / Wij raden u aan deze handleiding zorgvuldig te lezen en te bewaren voor eventuele raadpleging op een later tijdstip. / Leggere le istruzioni prima di cominciare ad usare il gioco e conservarle per referenze future. / Leia as instruções antes do primeiro uso e guarde-as para futura referência.

EN ⚠ **WARNING:**
CHOKING HAZARD. - Small parts.
Not for children under 3 years.

ES ⚠ **ADVERTENCIA:**
PELIGRO DE ASFIXIA. - Contiene piezas pequeñas.
No recomendado para niños menores de 3 años.

FR ⚠ **AVERTISSEMENT:**
RISQUE DE SUFFOCATION. - Présence de petits éléments.
Ne convient pas aux enfants de moins de 3 ans.

DE ⚠ **WARNUNG:**
ERSTICKUNGSGEFAHR. - Enthält kleine Teile.
Nicht für Kinder unter 3 Jahren geeignet.

NL ⚠ **WAARSCHUWING:**
VERSTIKKINGSGEVAAR. - Bevat kleine onderdelen.
Niet geschikt voor kinderen onder de 3 jaar.

DA ⚠ **ADVARSEL:**
KVÆLNINGSFARE. - Indeholder smådele.
Ikke til børn under 3 år.

EL ⚠ **ΠΡΟΕΙΔΟΠΟΙΗΣΗ:**
ΚΙΝΔΥΝΟΣ ΠΝΙΞΙΜΑΤΟΣ. - Περιέχει μικρά αντικείμενα.
Όχι για παιδιά κάτω των 3 ετών.

FI ⚠ **VAROITUS:**
TUKEHTUMISVAARA. - Sisältää pieniä osia.
Ei alle 3-vuotiaalle lapsille.

IT ⚠ **ATTENZIONE:**
PERICOLO DI SOFFOCAMENTO. - Contiene piccole parti.
Non indicato per bambini sotto i 3 anni.

NO ⚠ **ADVARSEL:**
KVELNINGSFARE. - Inneholder små deler.
Kun for barn over 3 år.

PT ⚠ **ATENÇÃO:**
PERIGO DE ASFIXIA. - Contém peças pequenas.
Não é concebido para crianças de menos de 3 anos.

SV ⚠ **VARNING:**
KVÄVNINGSRISK. - Innehåller små delar.
Inte för barn under 3 år.

JA ⚠ **警告:**
窒息の危険性 小さな部品が含まれています
3歳以下の子供には与えないで下さい。

ZH ⚠ **警告:**
有窒息危險。包含有小物件
不适合3岁以下的小孩玩。



EN Latex free toy.

ES Juguete sin látex.

FR Jouet sans latex.

DE Latexfreies Spielzeug.

NL Speelgoed vrij van latex.

DA Dette legetøj indeholder ikke latexgummi.

EL Παίχνιδι χωρίς λάτεξ.

FI Lelu ei sisällä lateksia.

IT Non contiene latex.

NO Leksak fri leketøy.

PT Brinquedo sem conteúdo de latex.

SV Leksak utan latex.

JA この玩具にはラテックスは使用されていません。

ZH 無乳膠玩具。



Spider-Man 3, the Movie ©2007 Columbia Pictures Industries, Inc. Spider-Man, the Character: TM & © 2007 Marvel Characters, Inc. All Rights Reserved. Super Hero(es) is a co-owned registered trademark.



2x

2x

1x

1x

1x

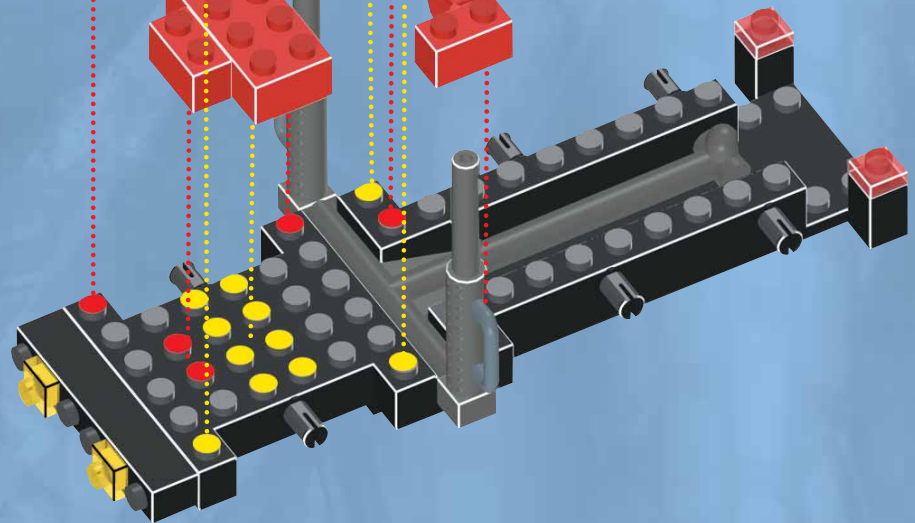
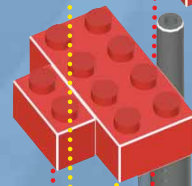
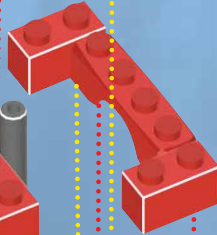
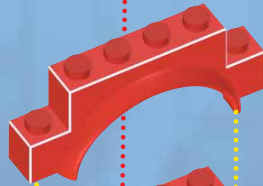
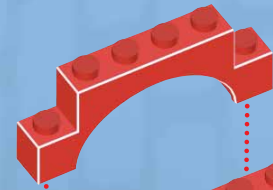
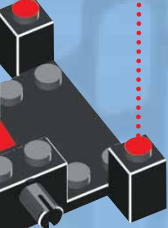
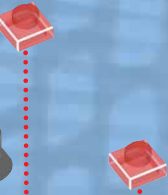
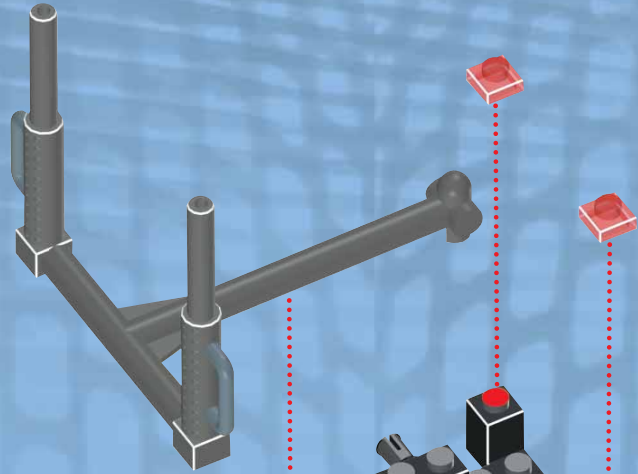
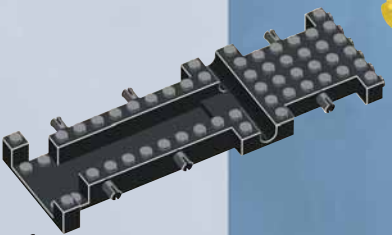
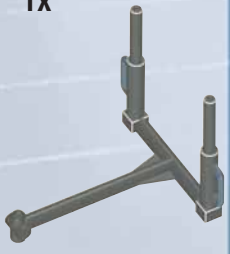
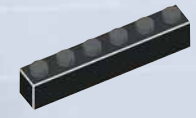

3x

1x

1x

2x

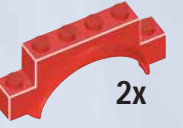
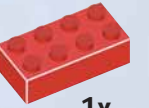



2x



1x

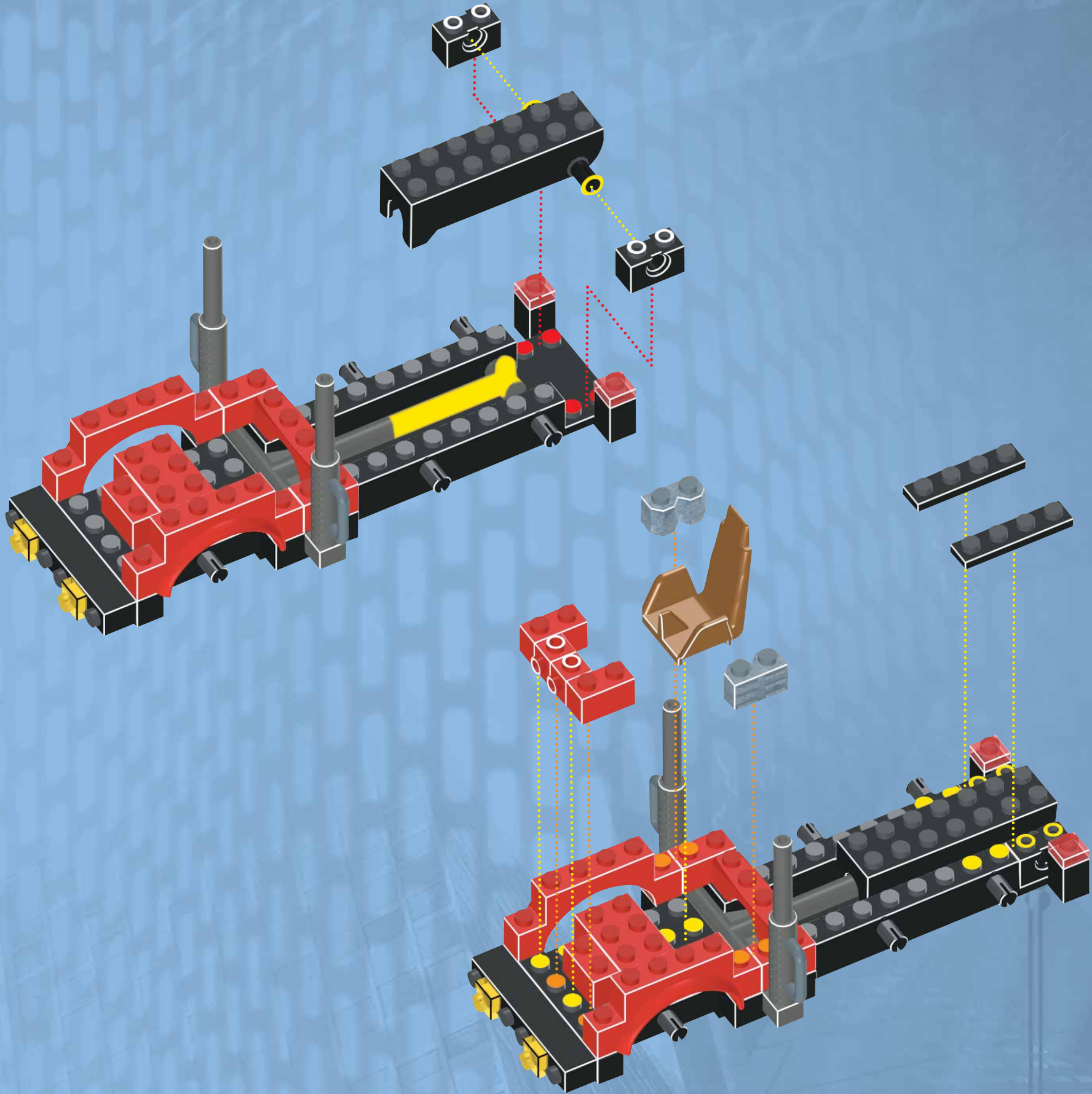

2x



2x



2x



2x



1x





2x

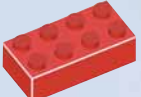

2x



1x

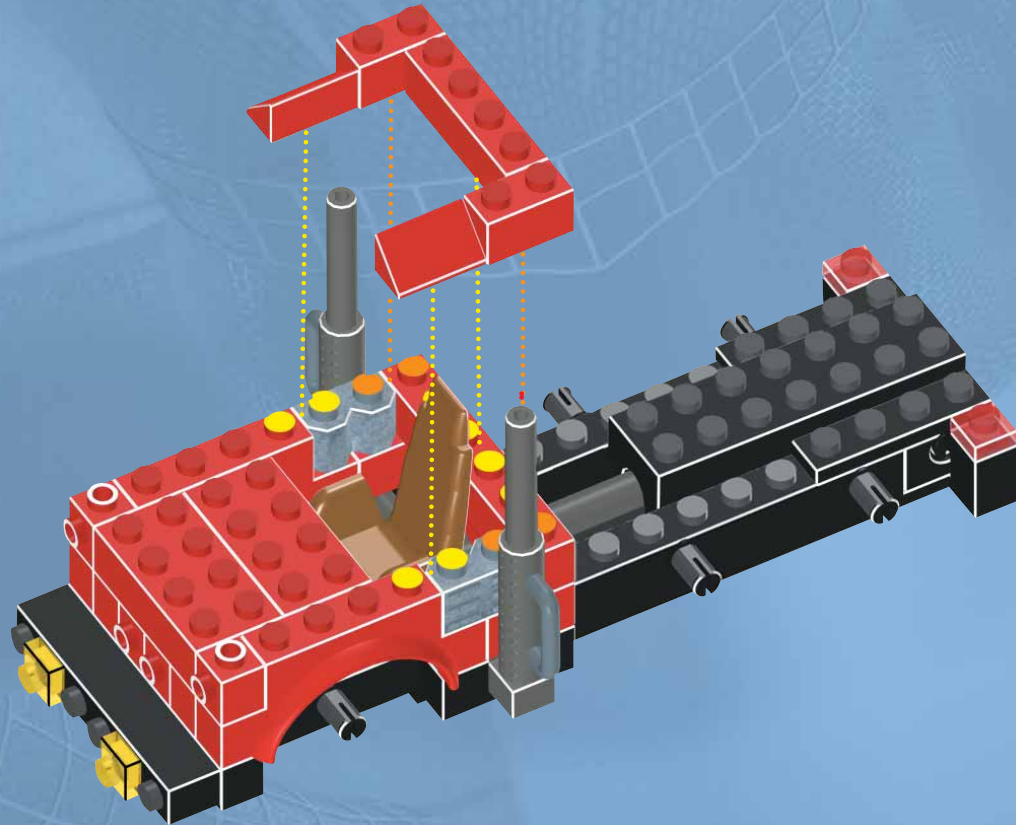
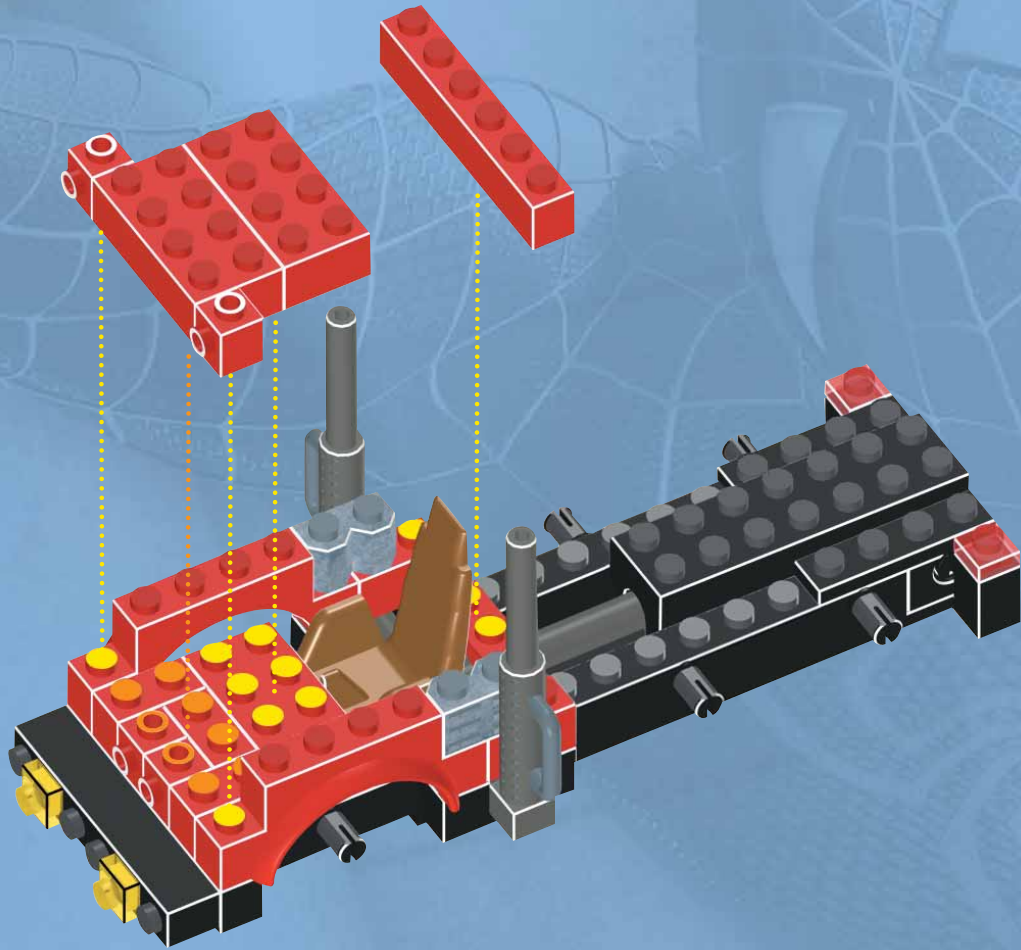

2x



2x



1x





2x



2x

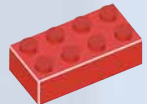

1x

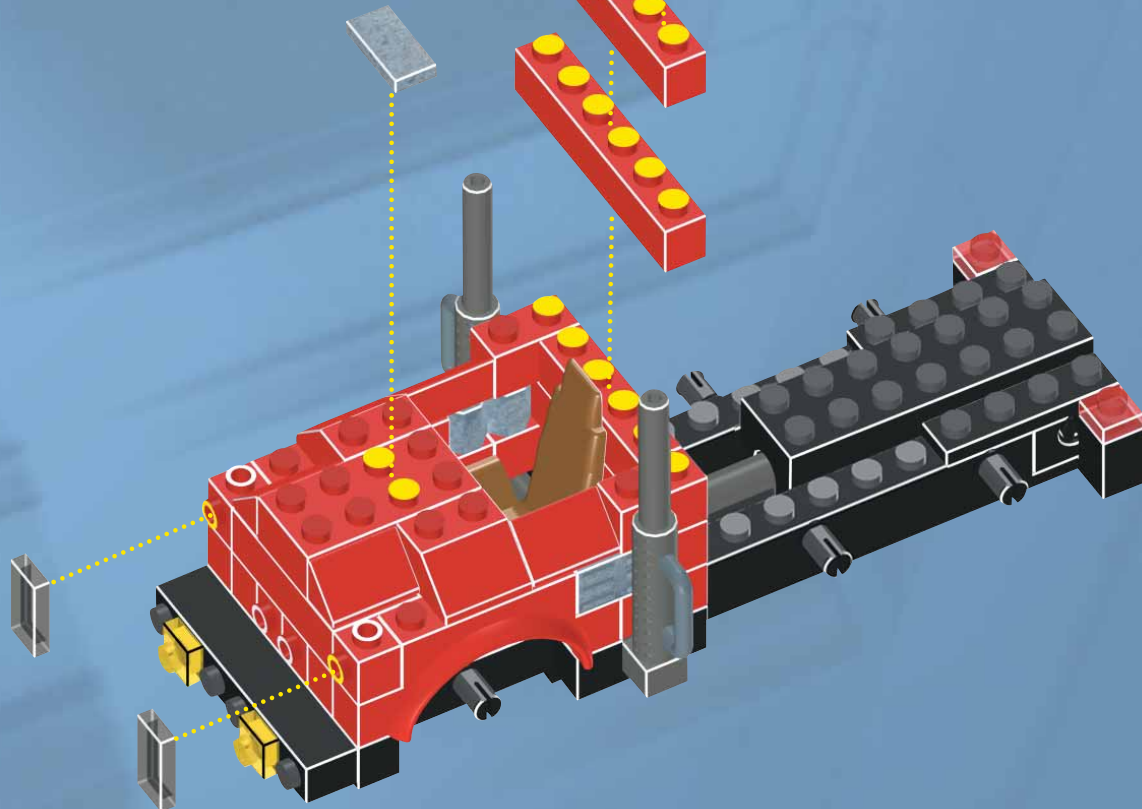
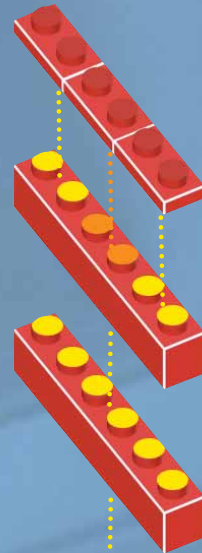
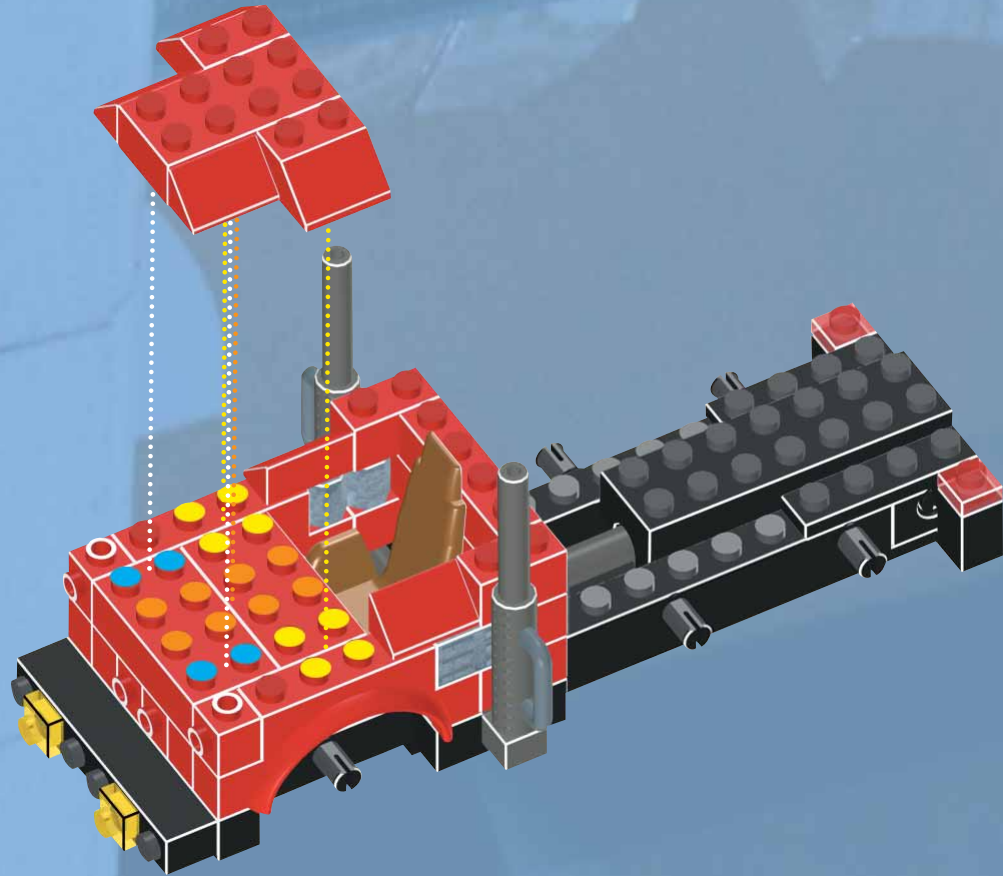

3x



1x



2x

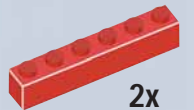

2x





6x



2x

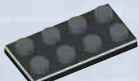

1x

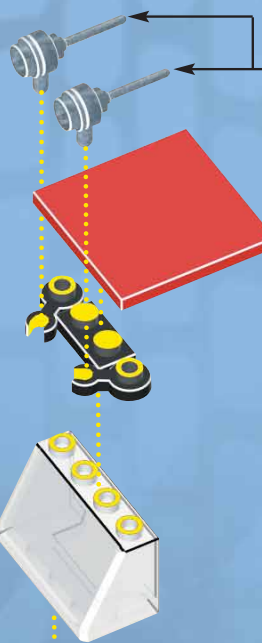
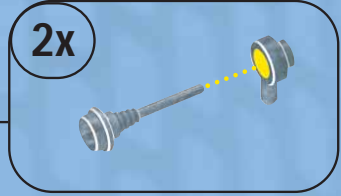
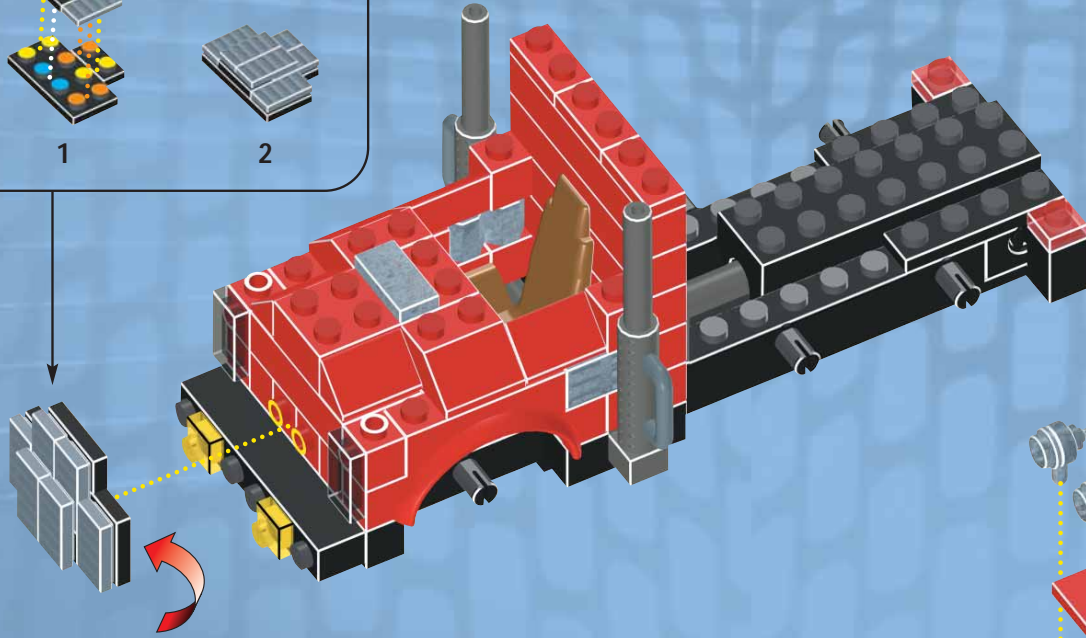
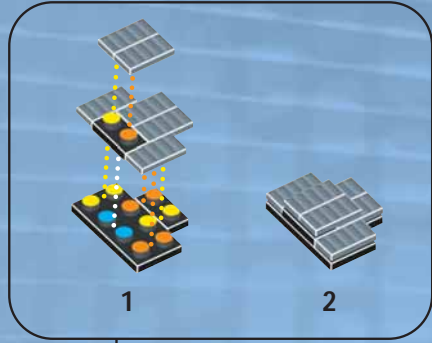

2x



2x



2x



1x



1x



1x





4x



1x

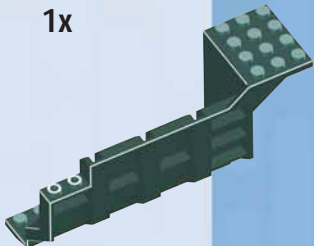

1x

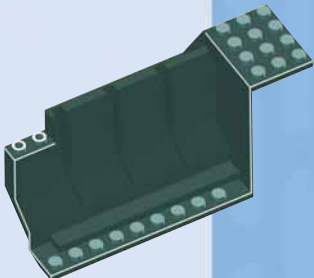

1x

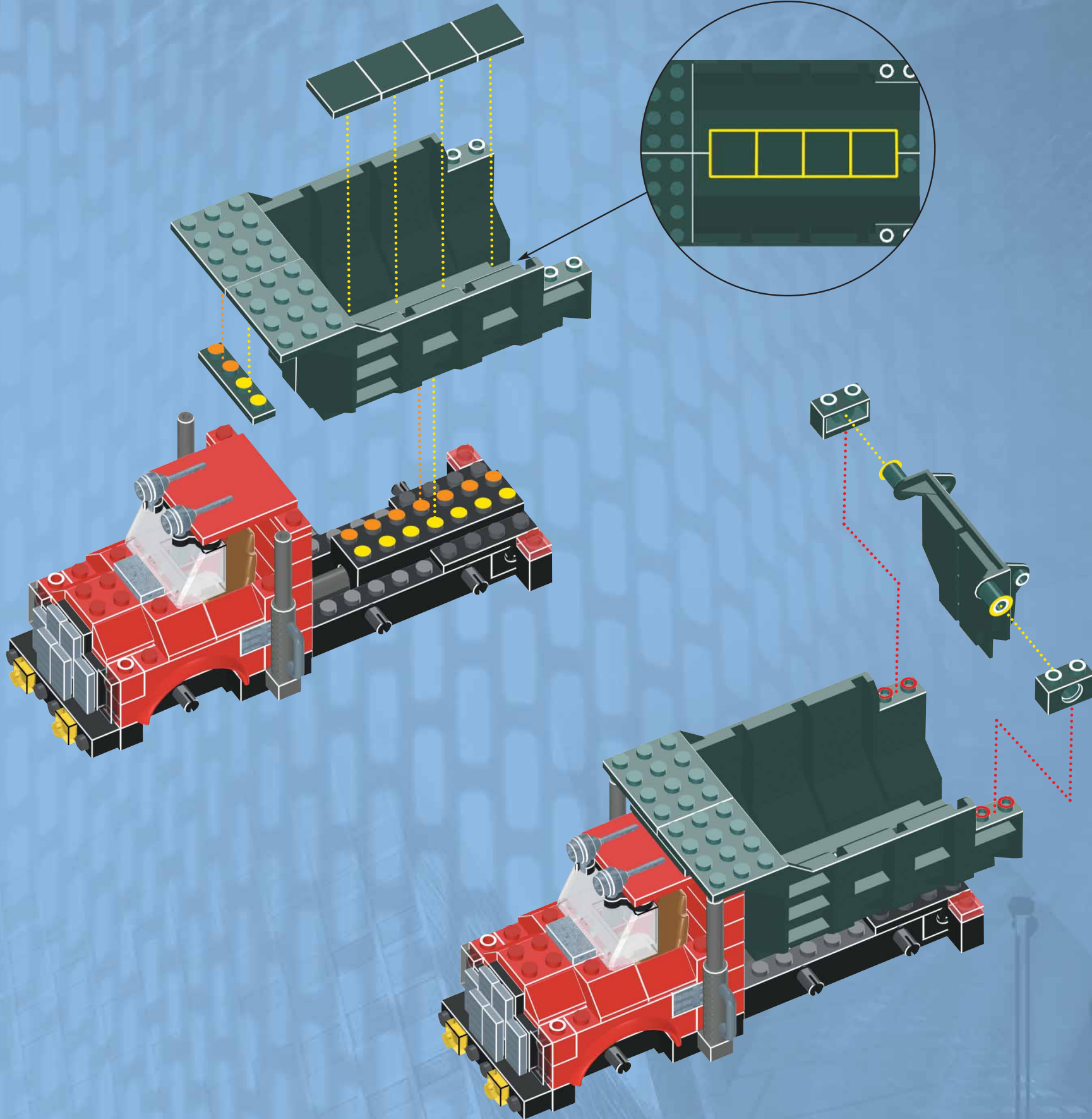

2x



1x



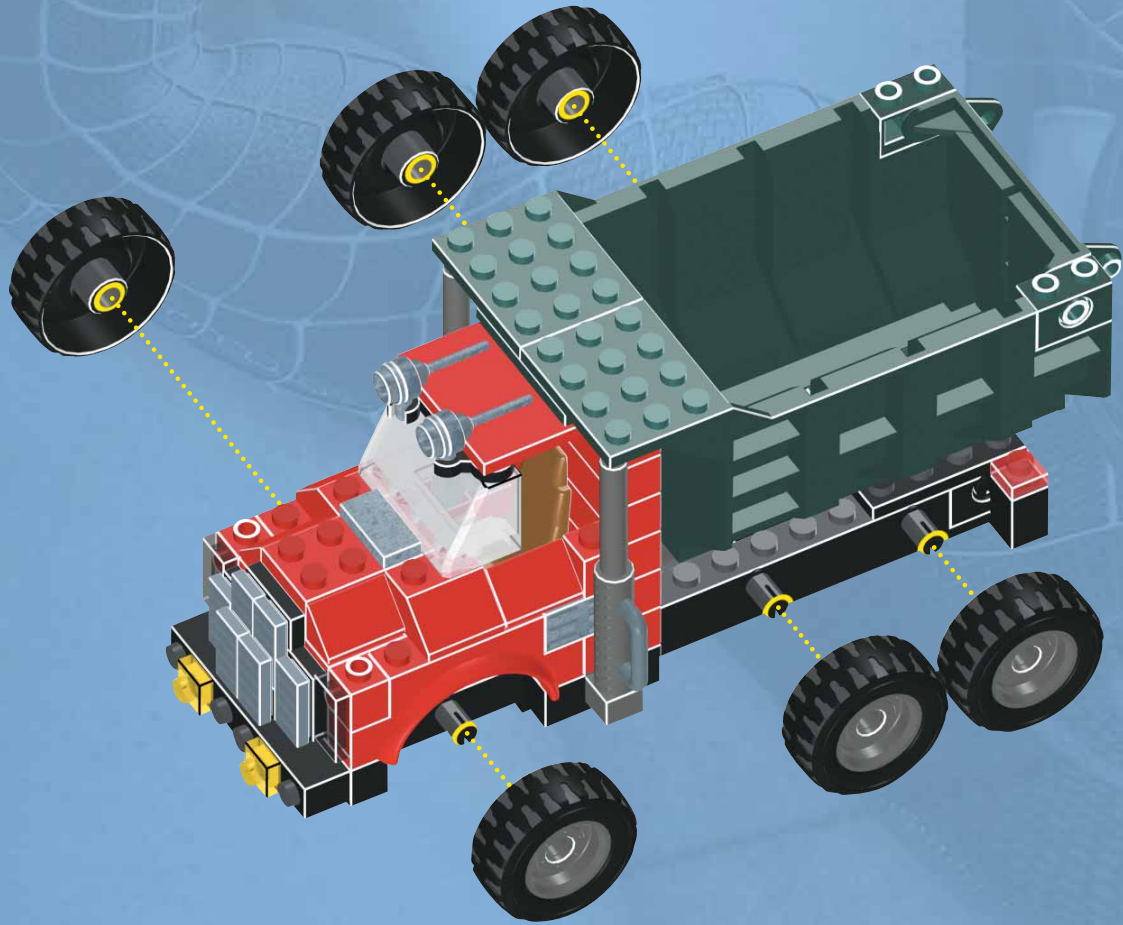

6x





2x



5x

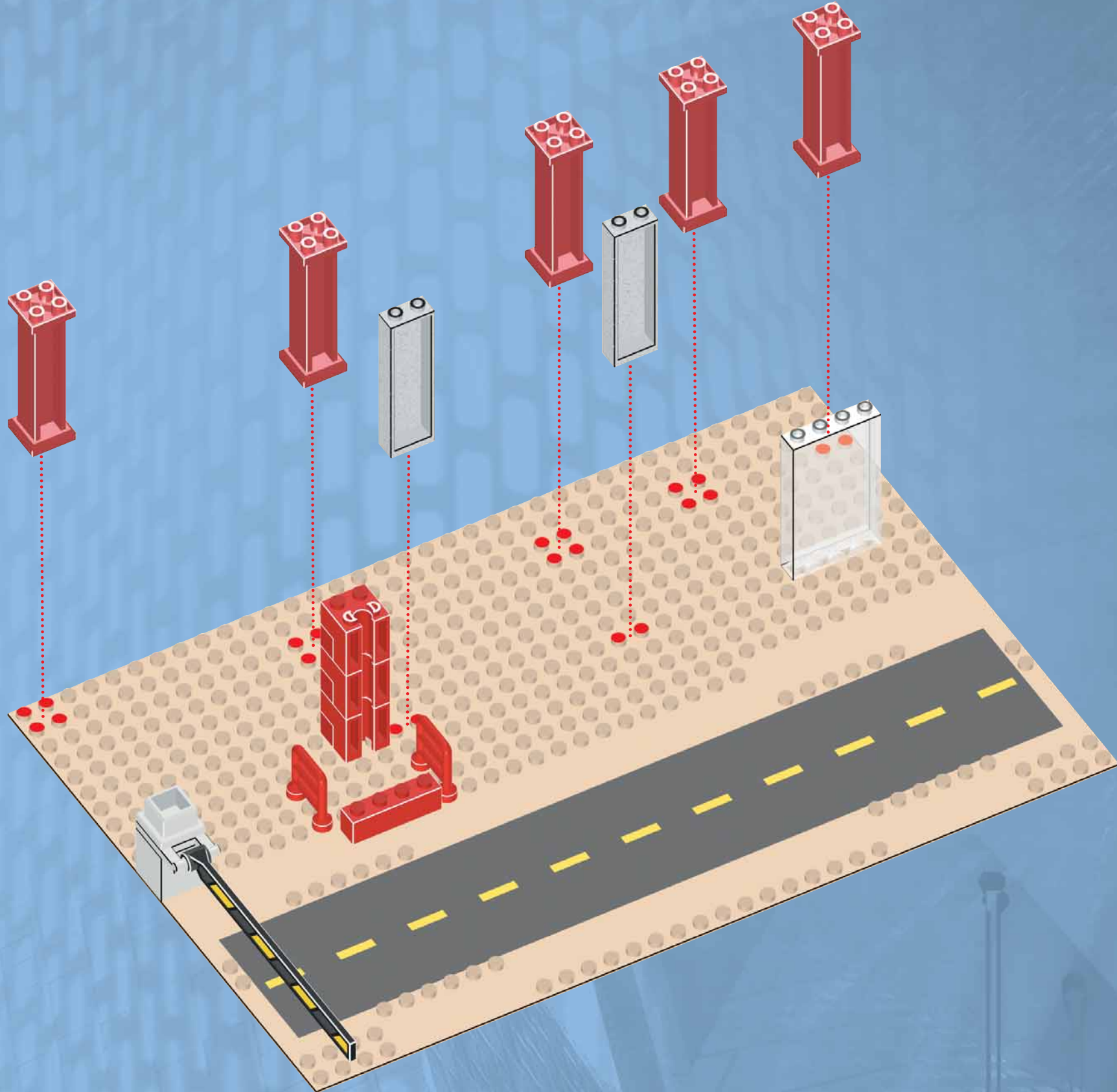

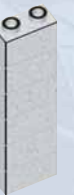
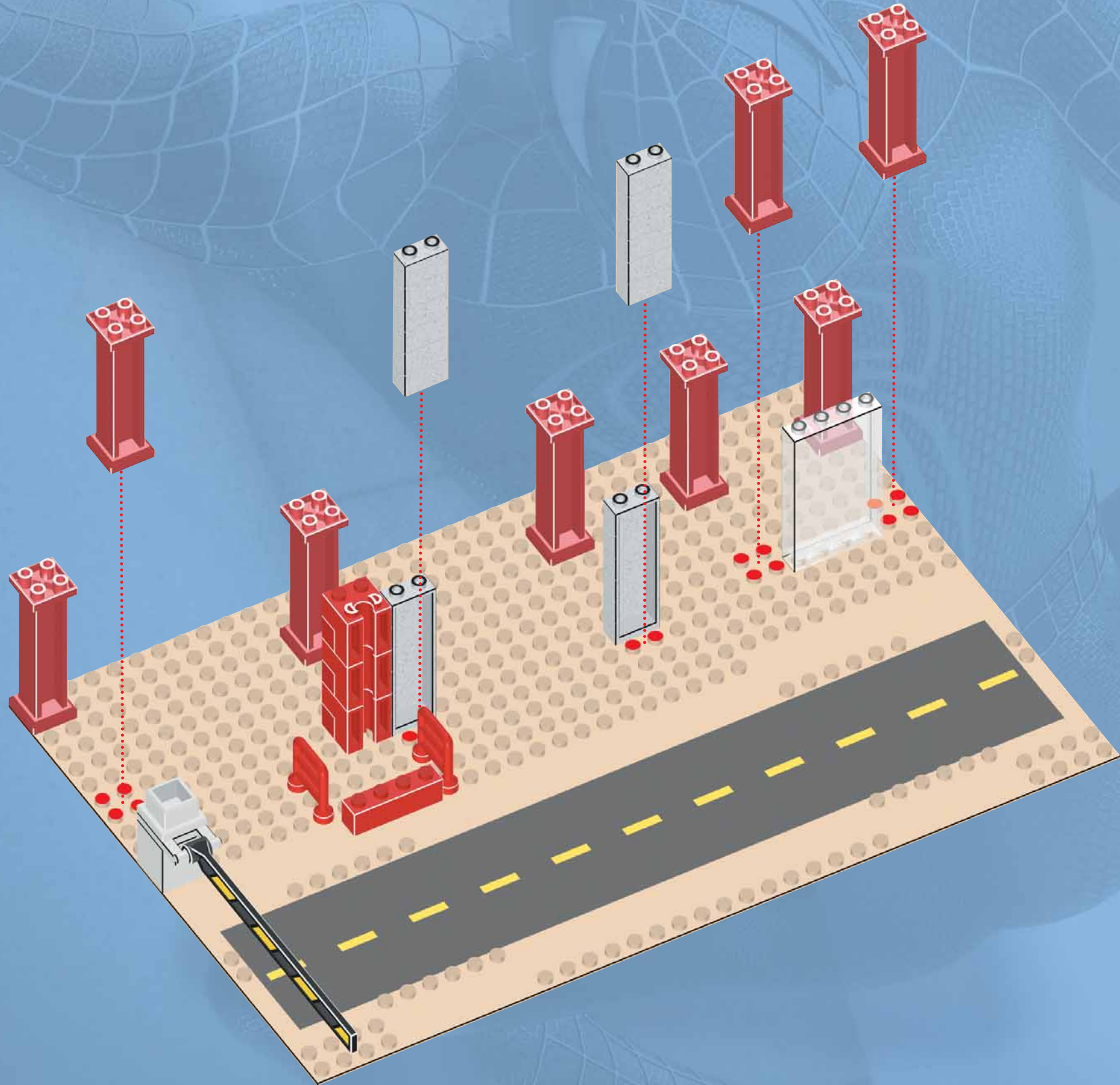

2x



3x

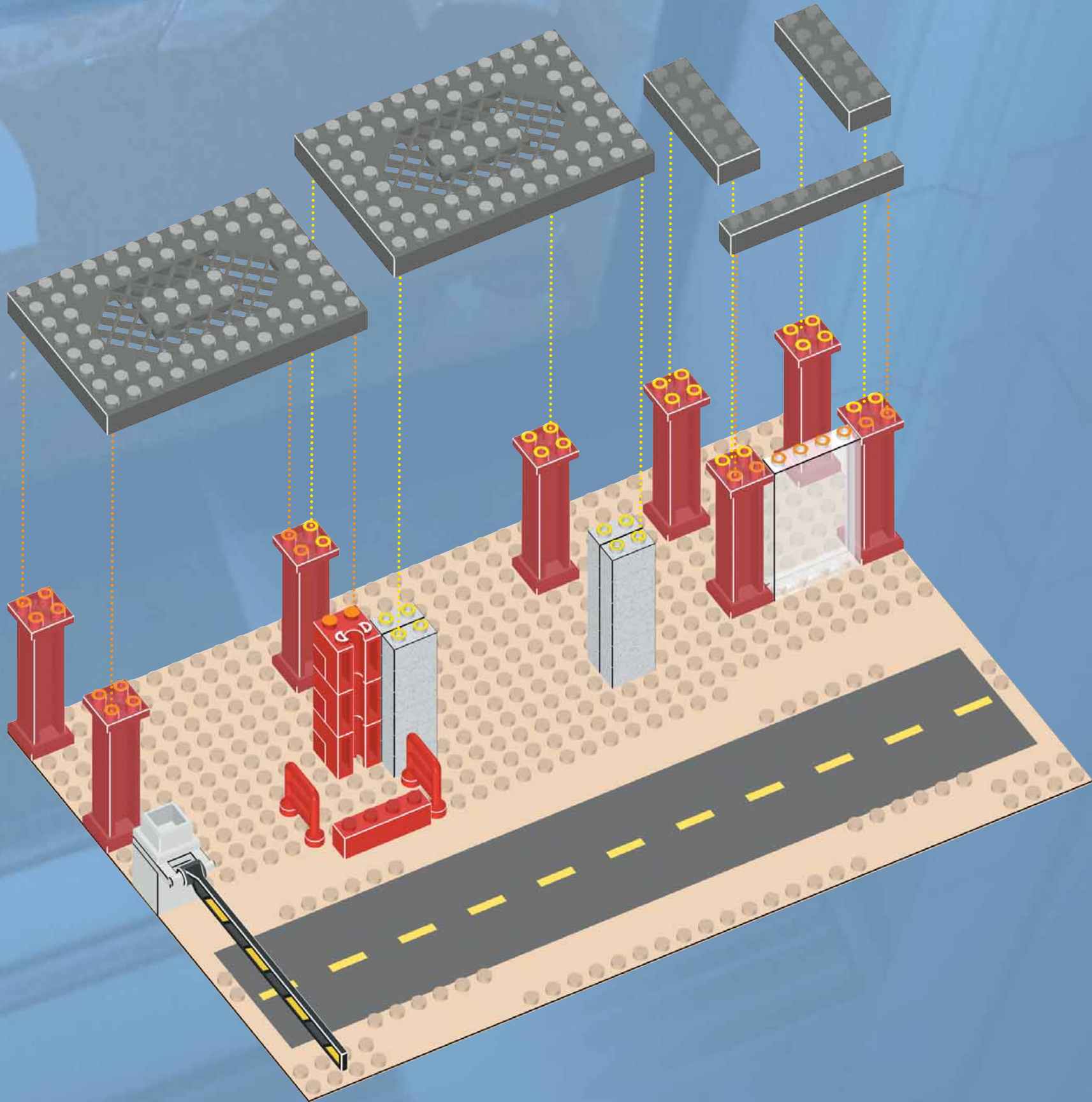
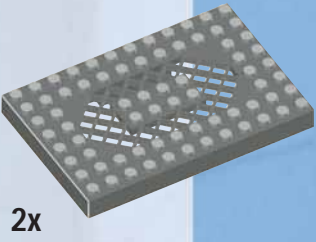
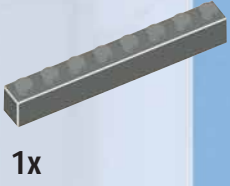
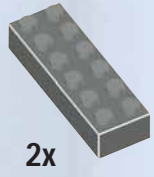

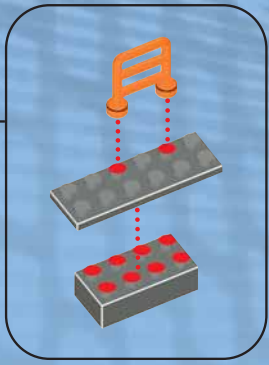
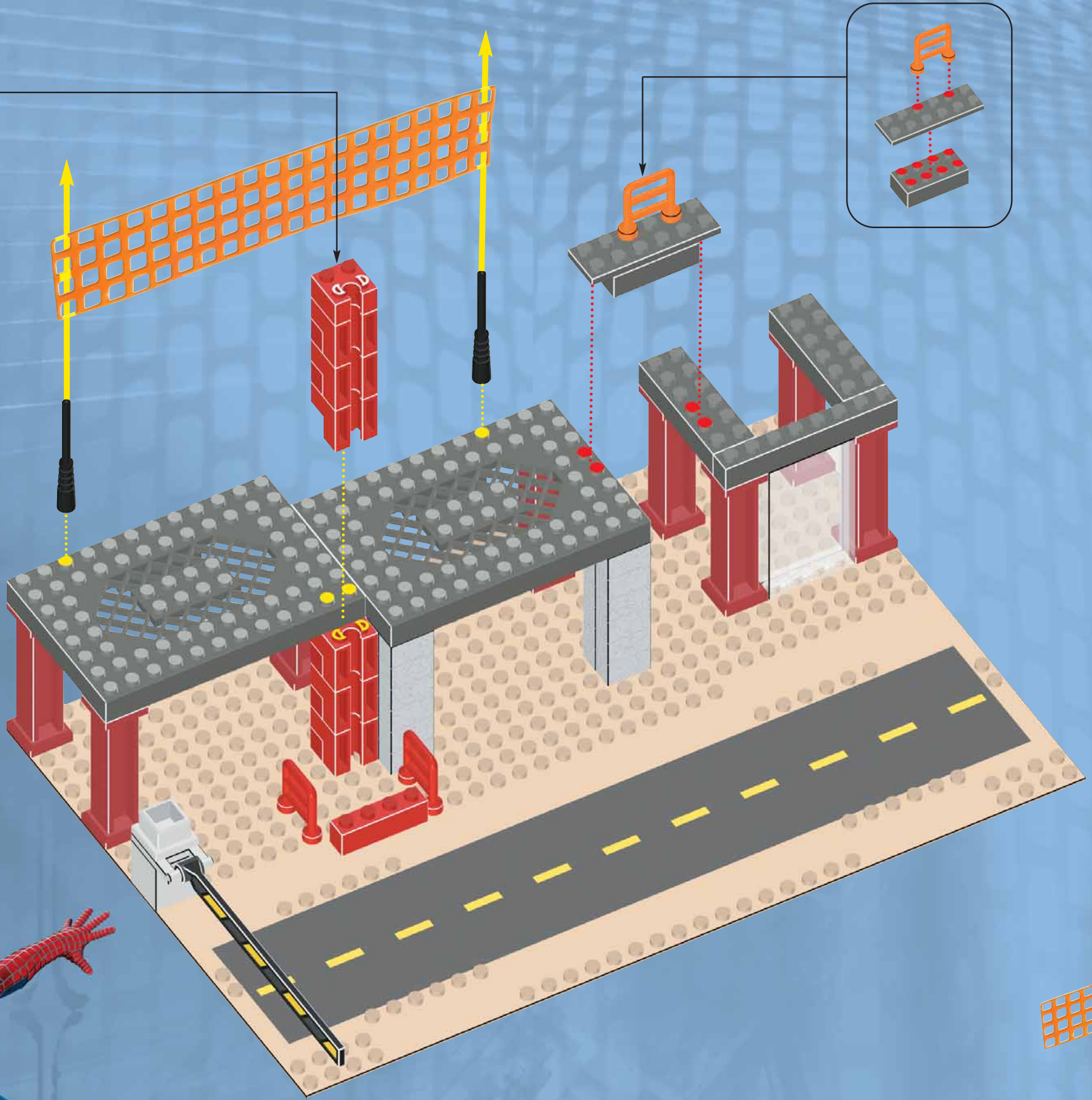
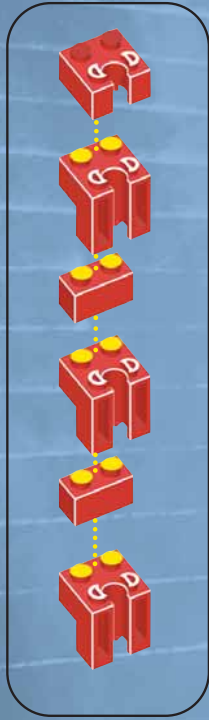

2x



2x



1x



1x



3x

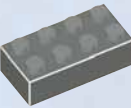

1x



1x

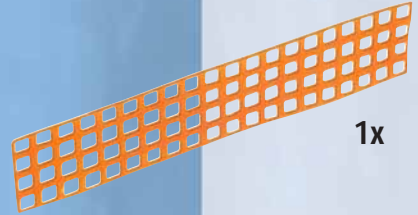

1x





1x



5x

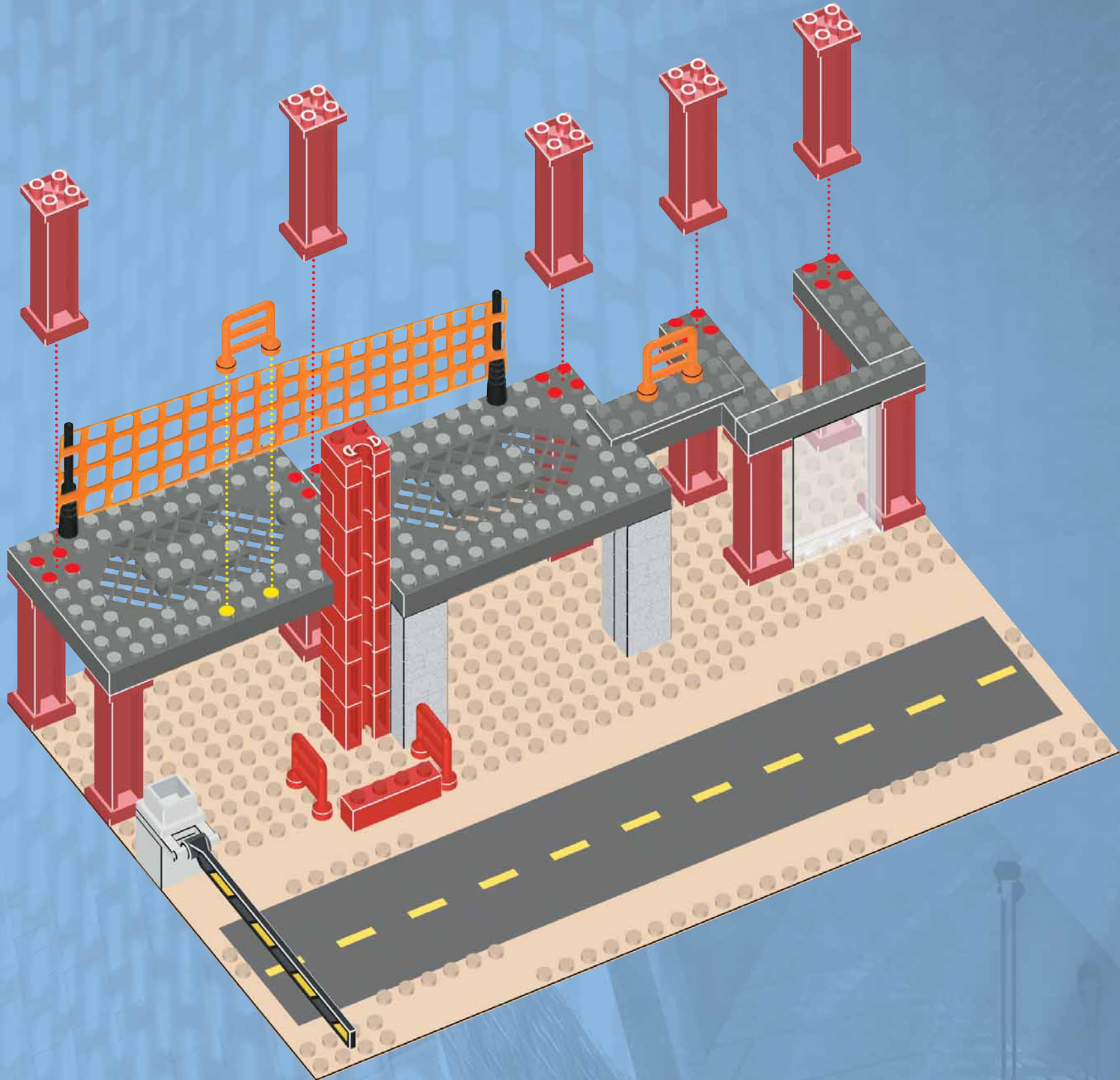

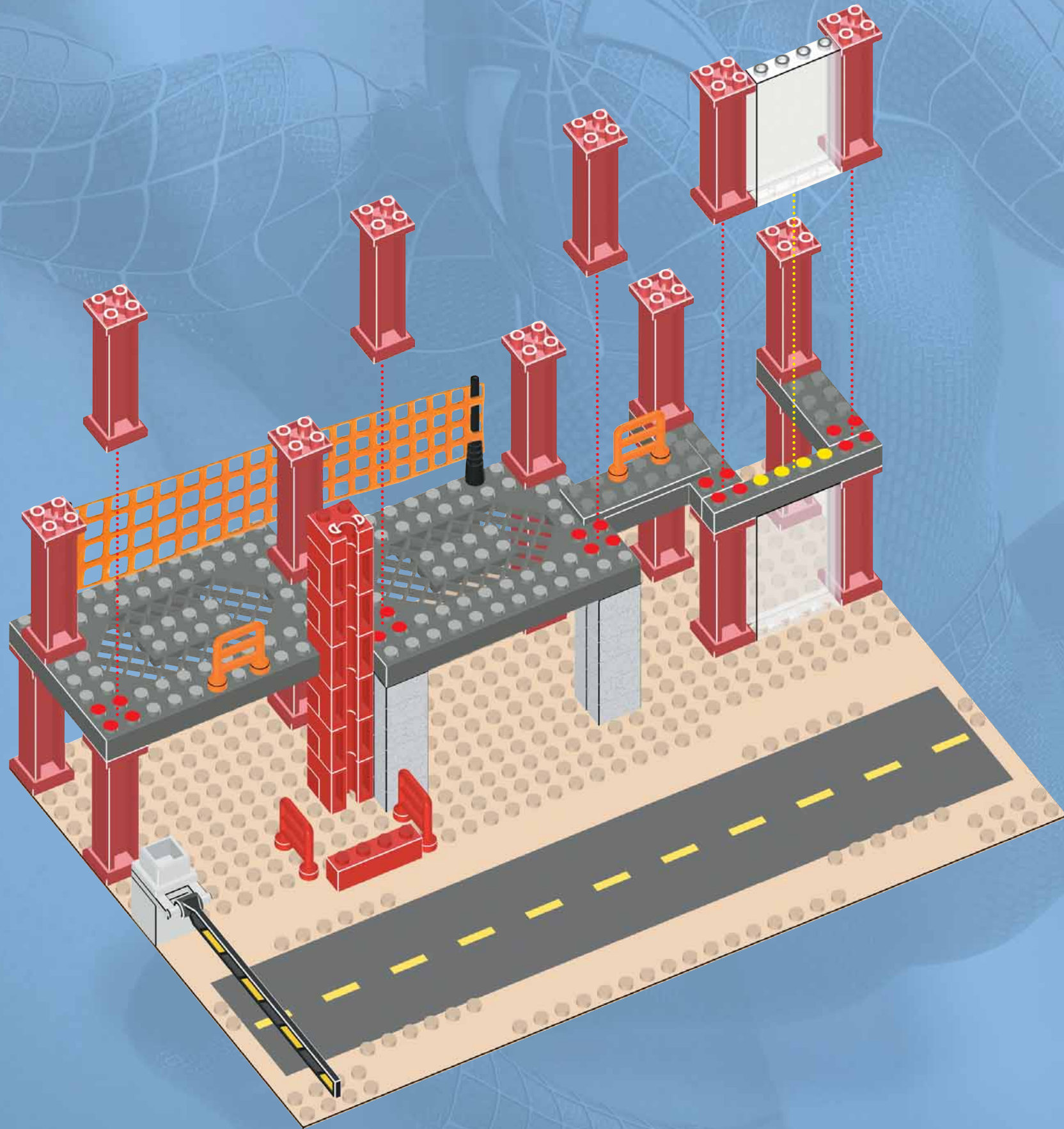

5x



1x

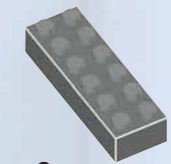

2x

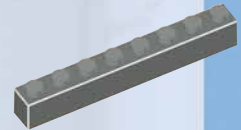

1x

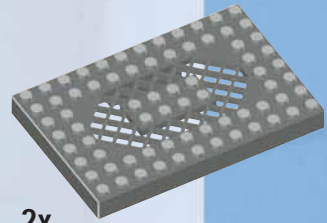

2x

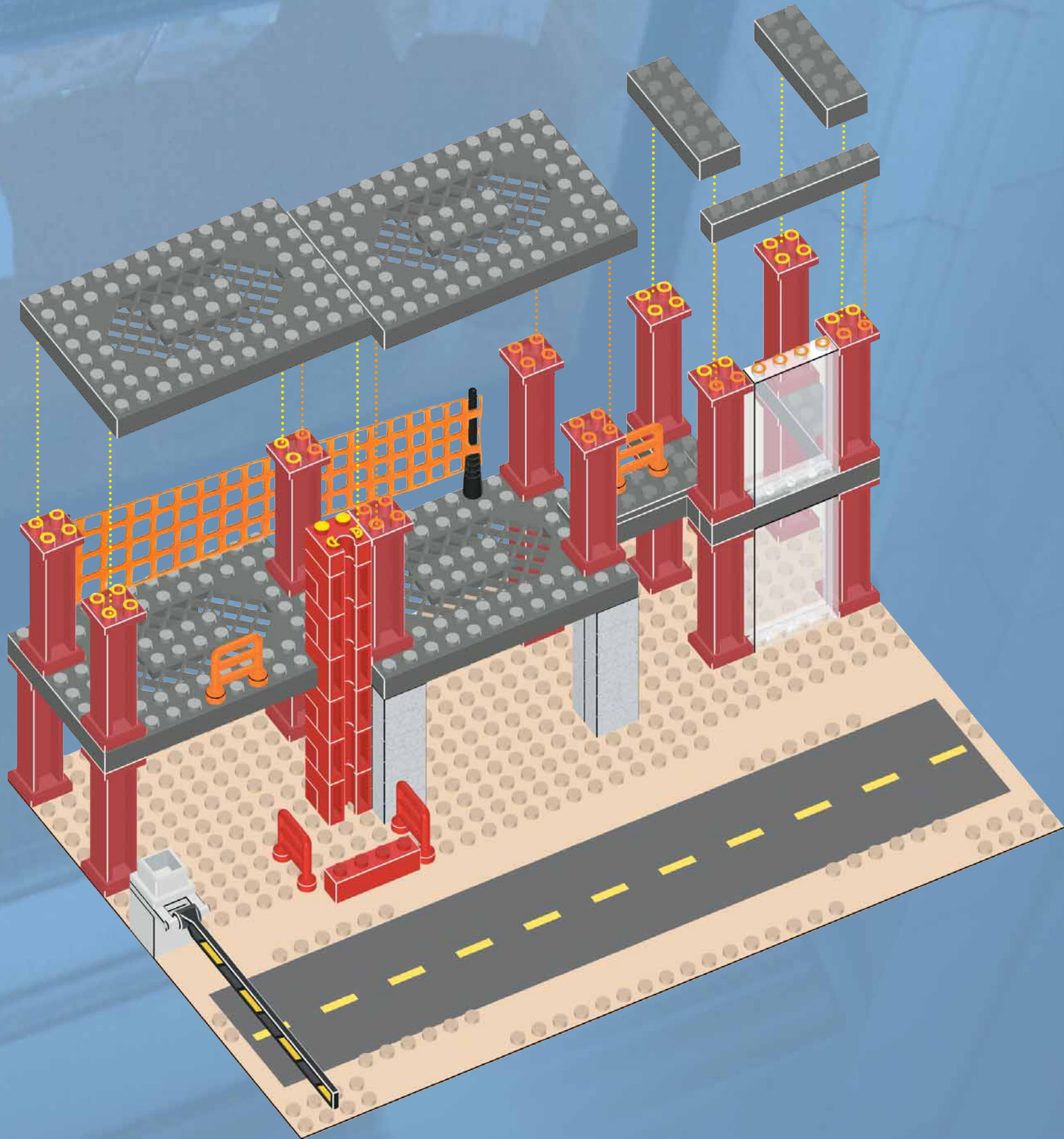

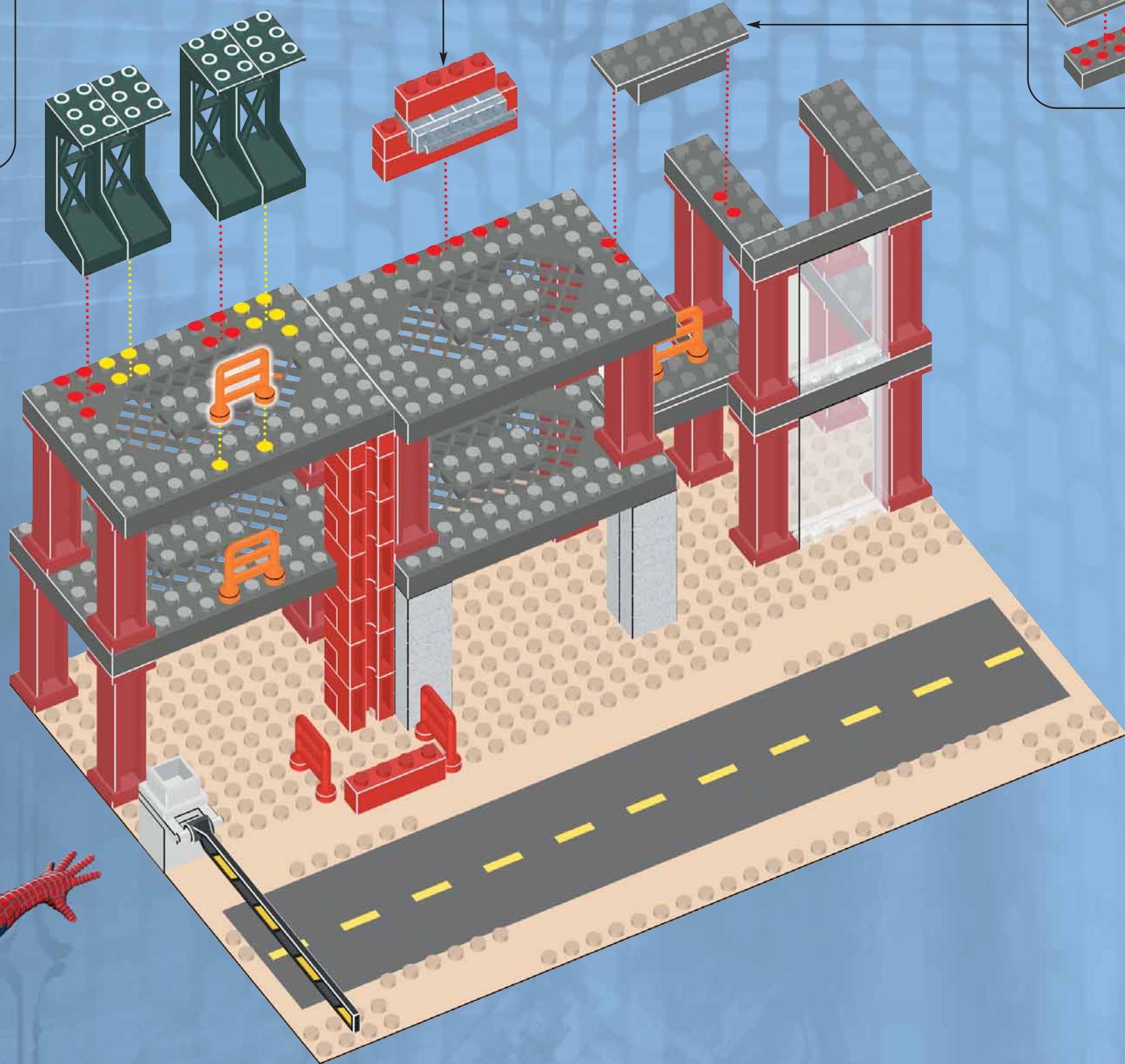
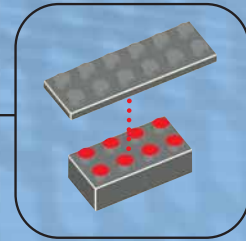
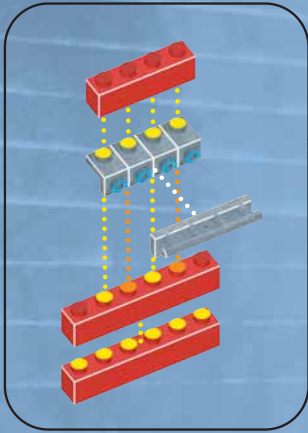

4x

1x

1x

1x

1x

1x

2x

4x





2x



2x



4x



1x

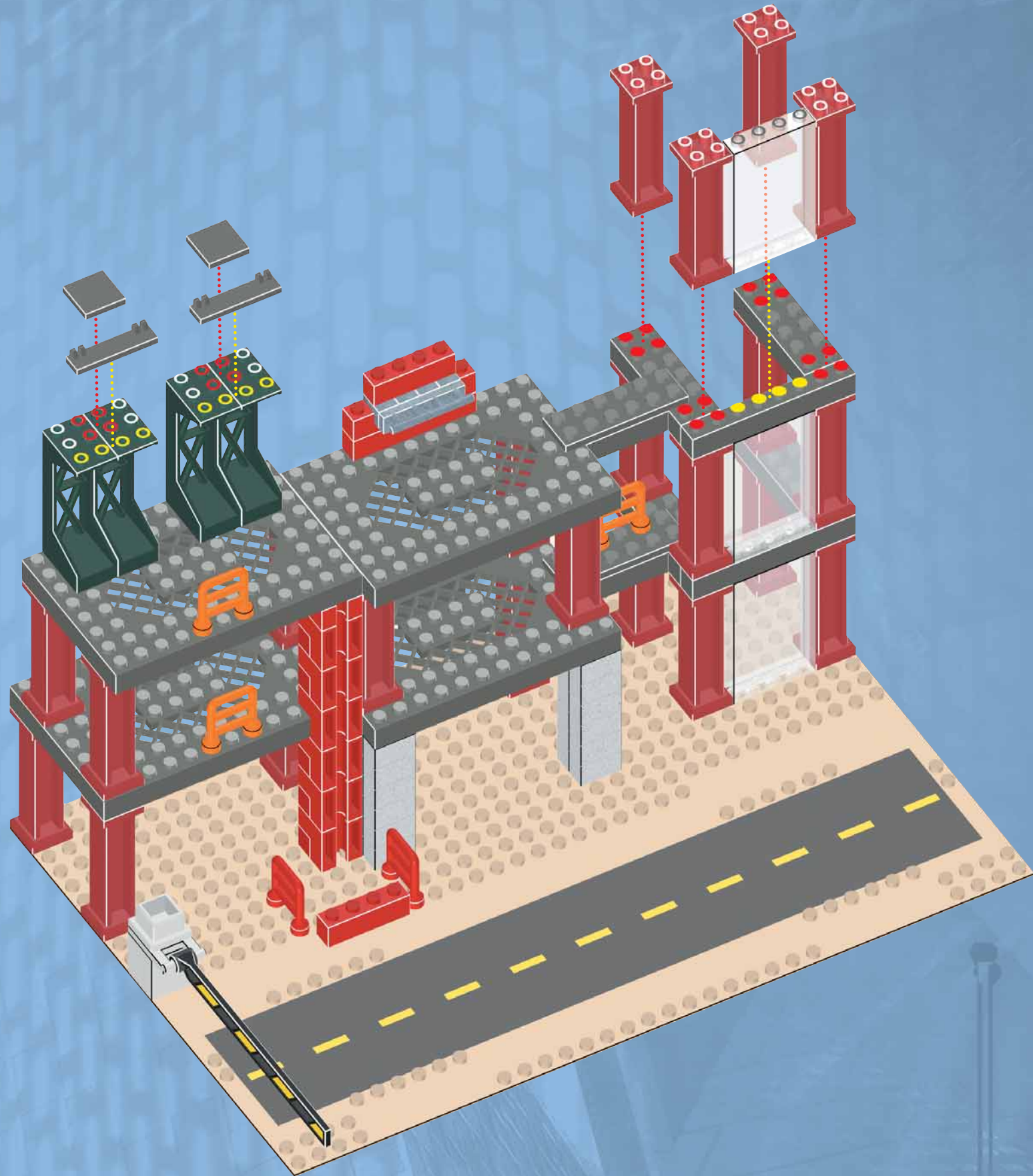

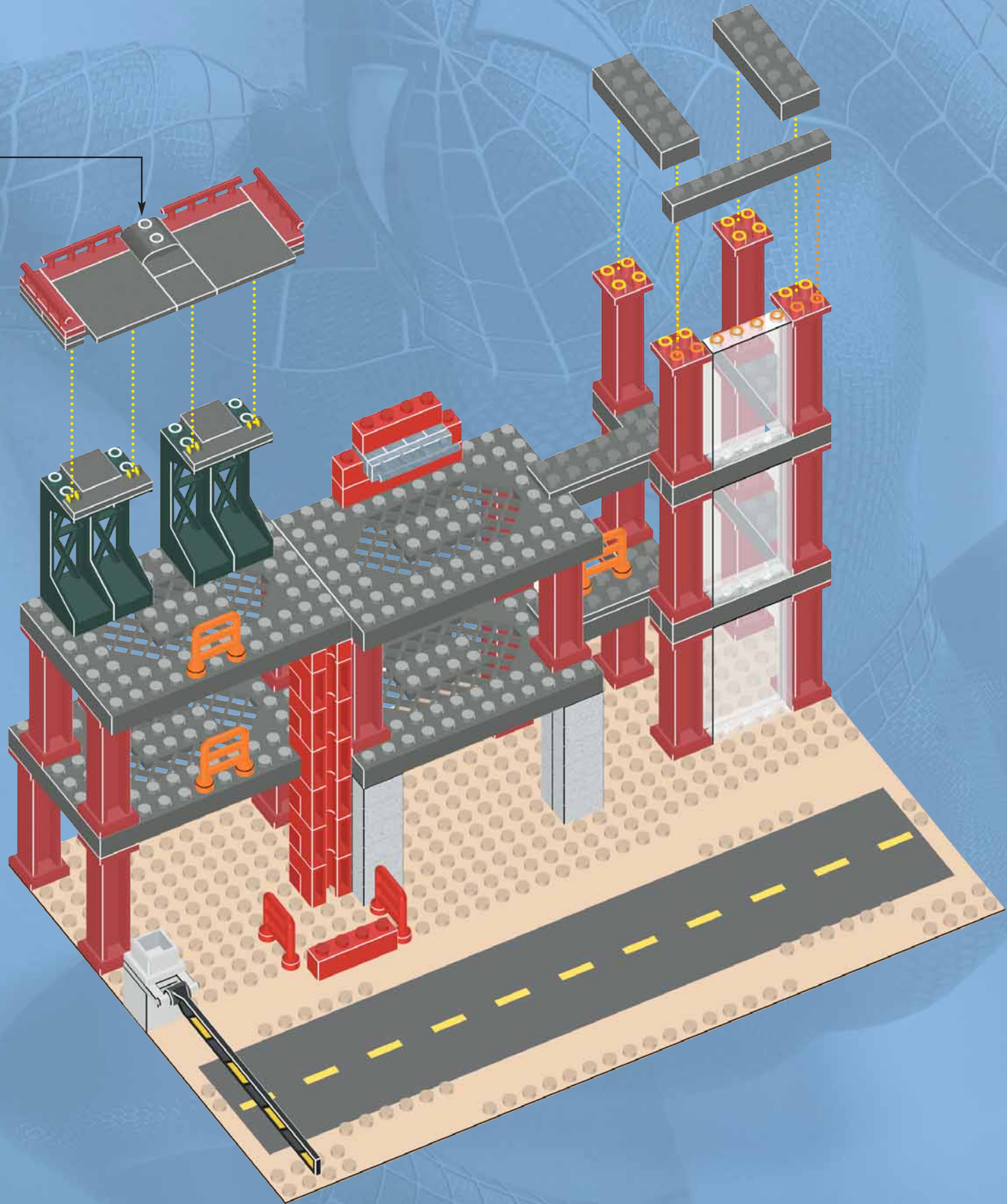
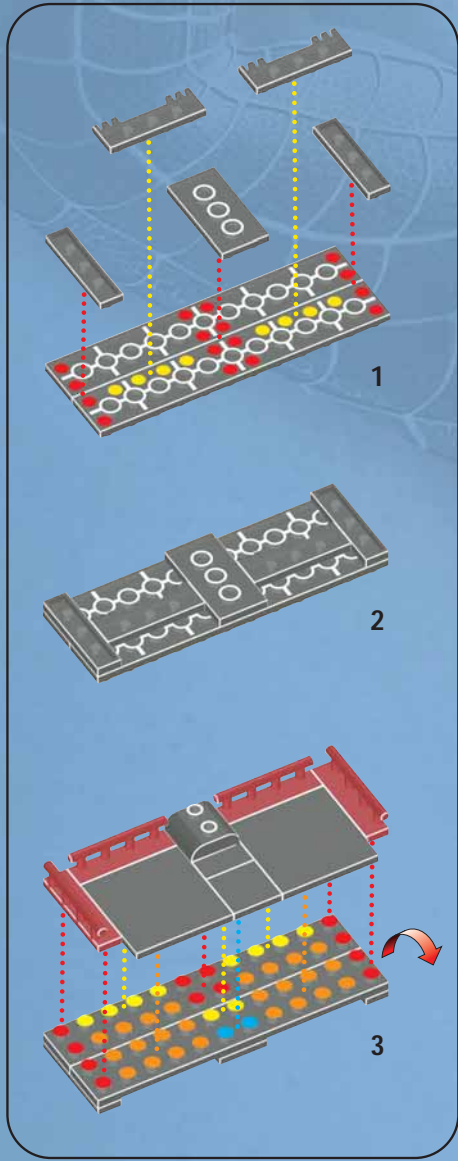

1x

1x

1x

2x

2x

4x

1x

2x

2x

1x

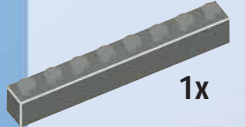







4x

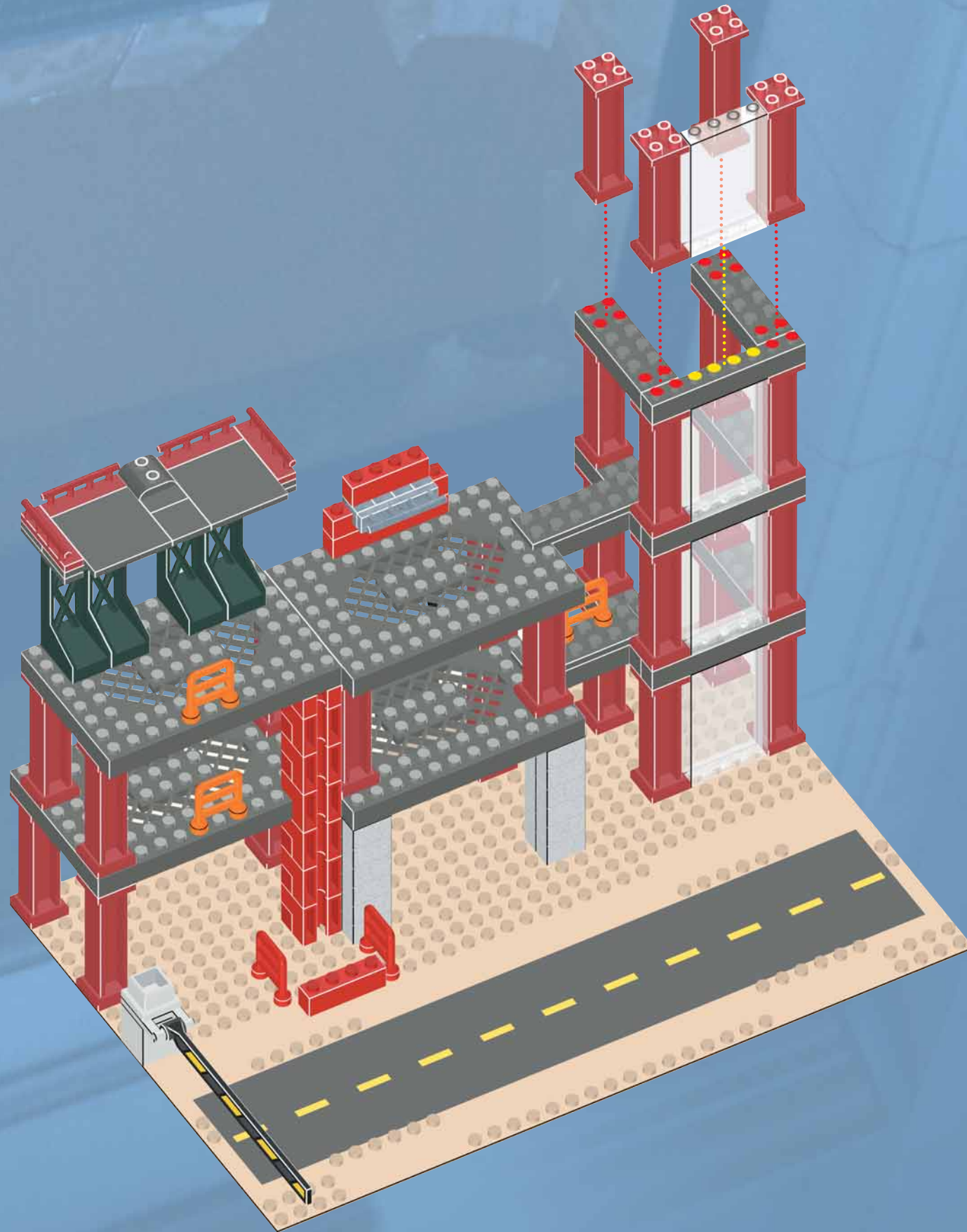

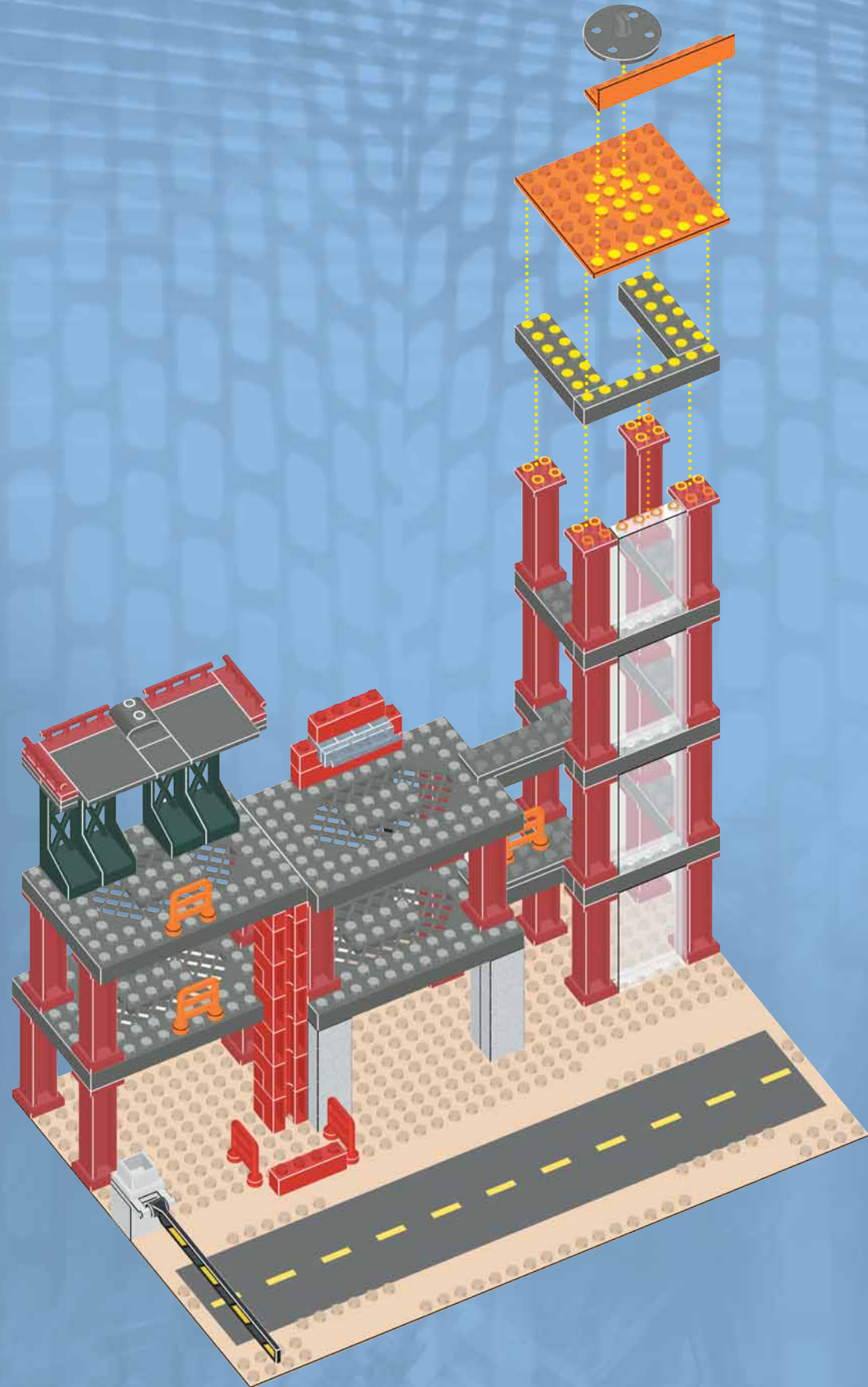
1x



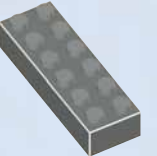

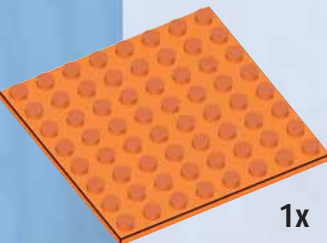
- 13  1x
-  1x
-  2x
-  1x
-  1x
-  1x



2x

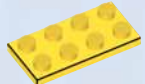

2x

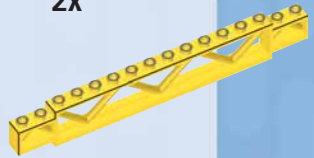

4x

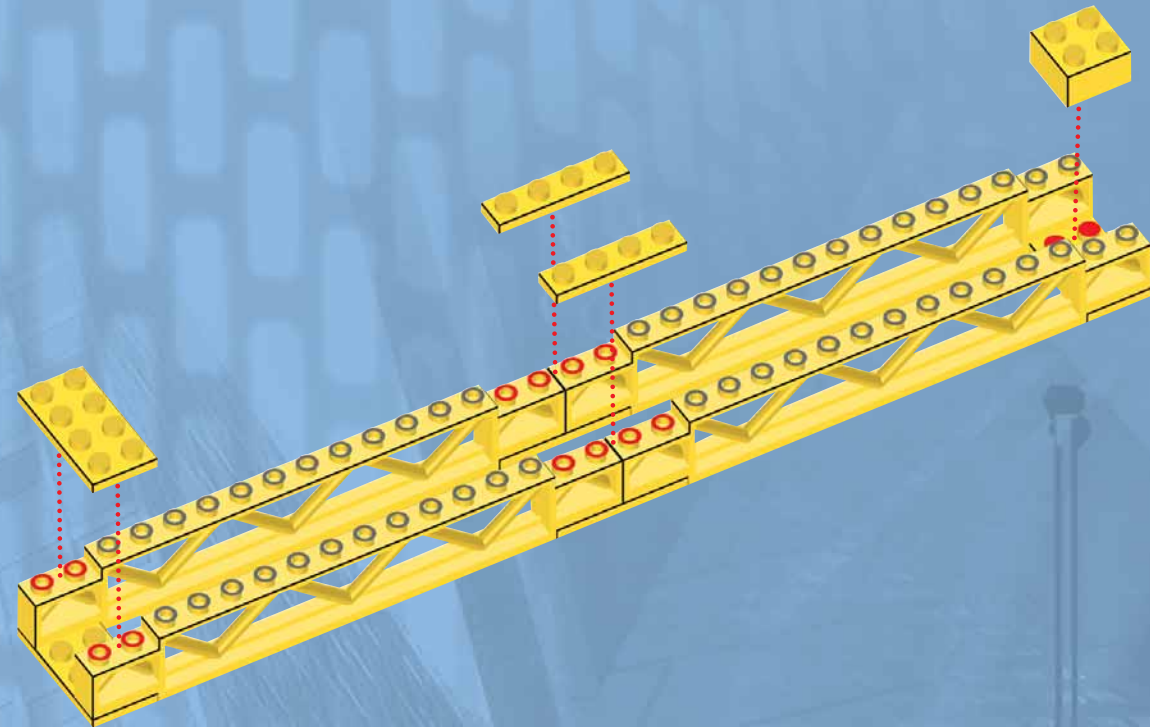
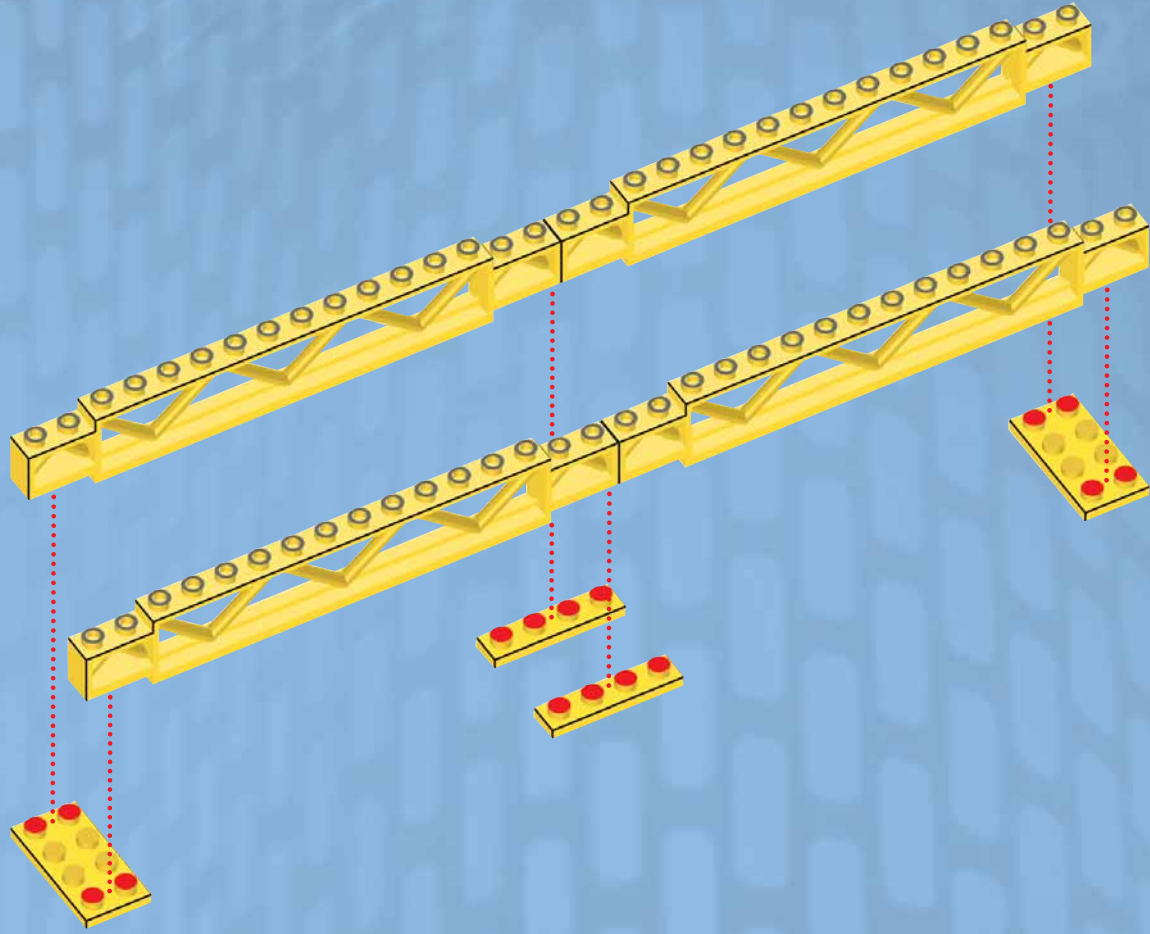

1x



2x



1x



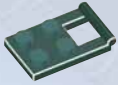

1x

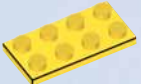

1x

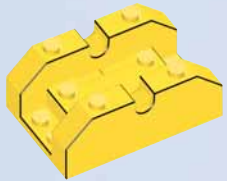

1x

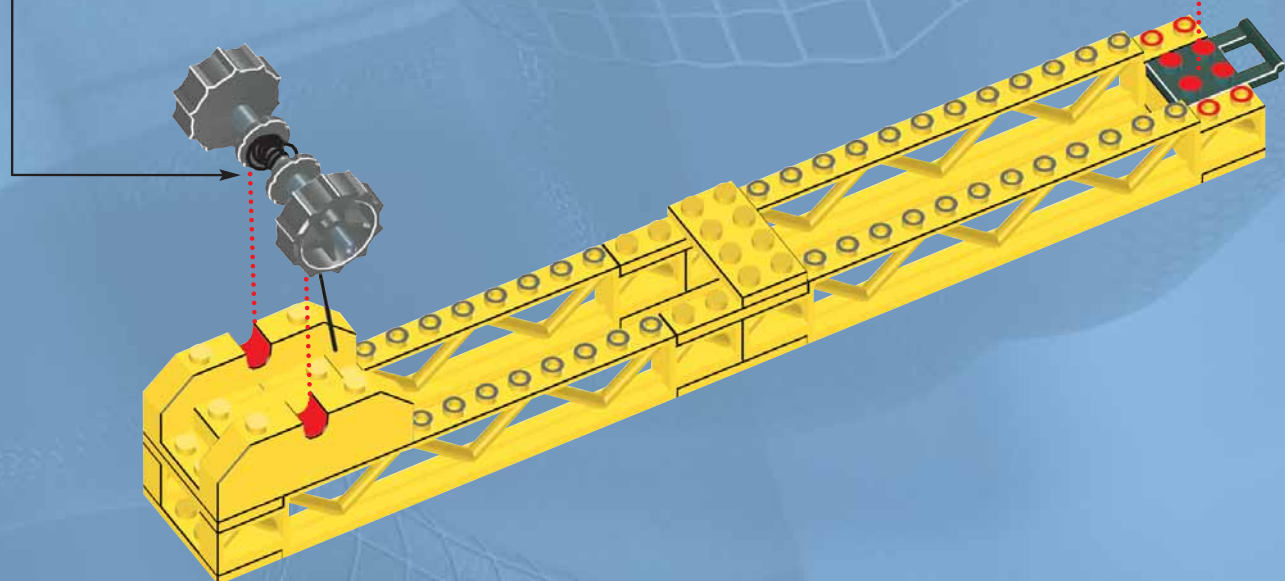
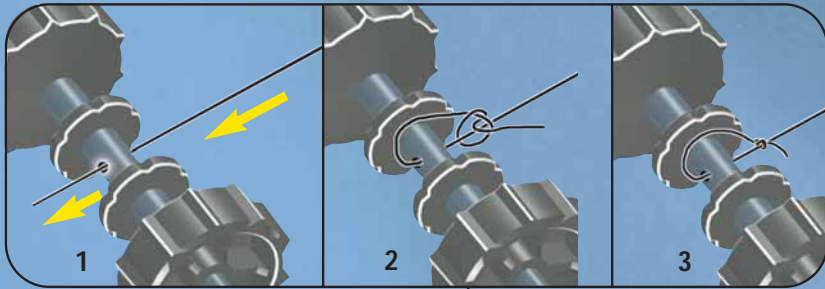
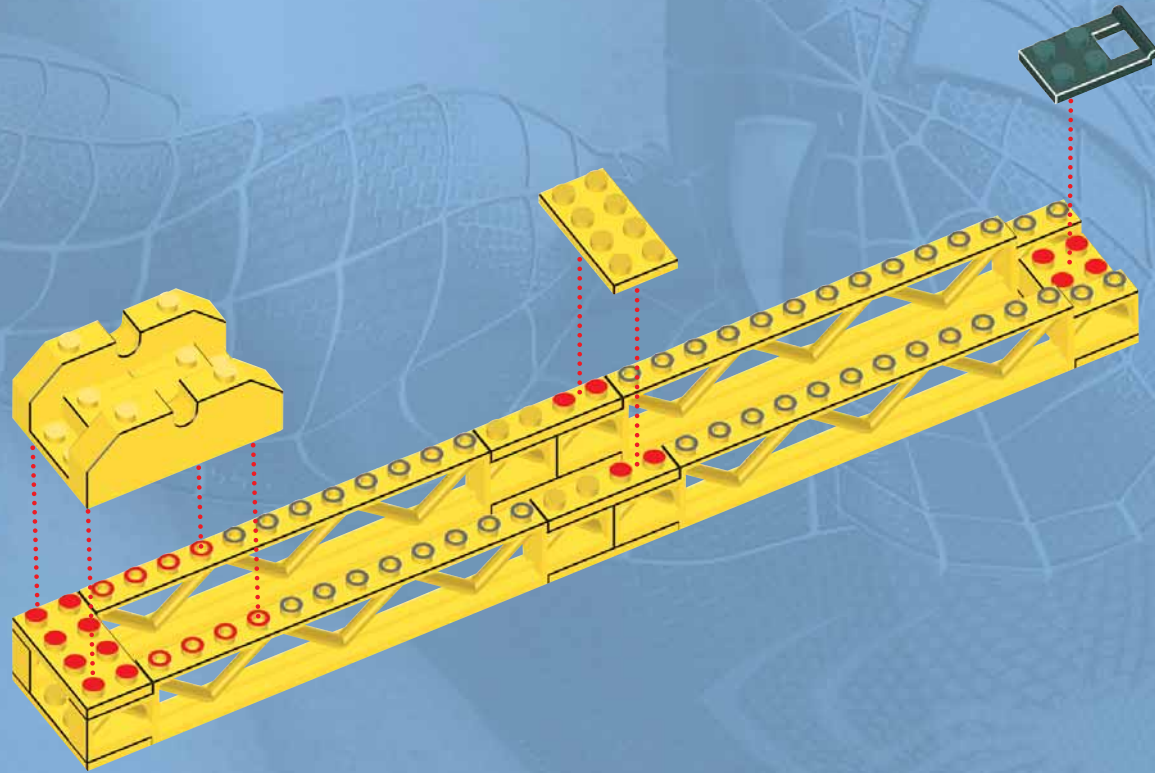

1x



1x

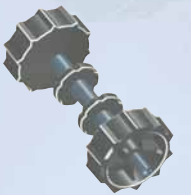

1x



4





1x

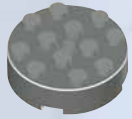

1x

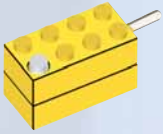

1x

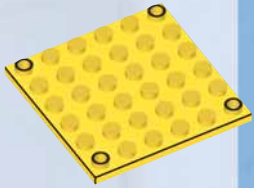

1x

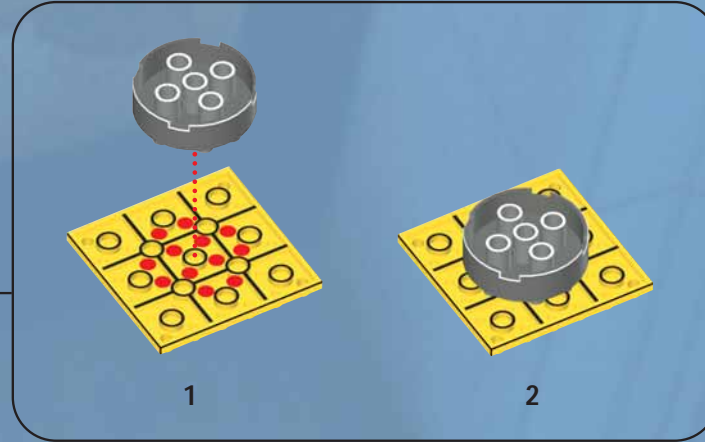
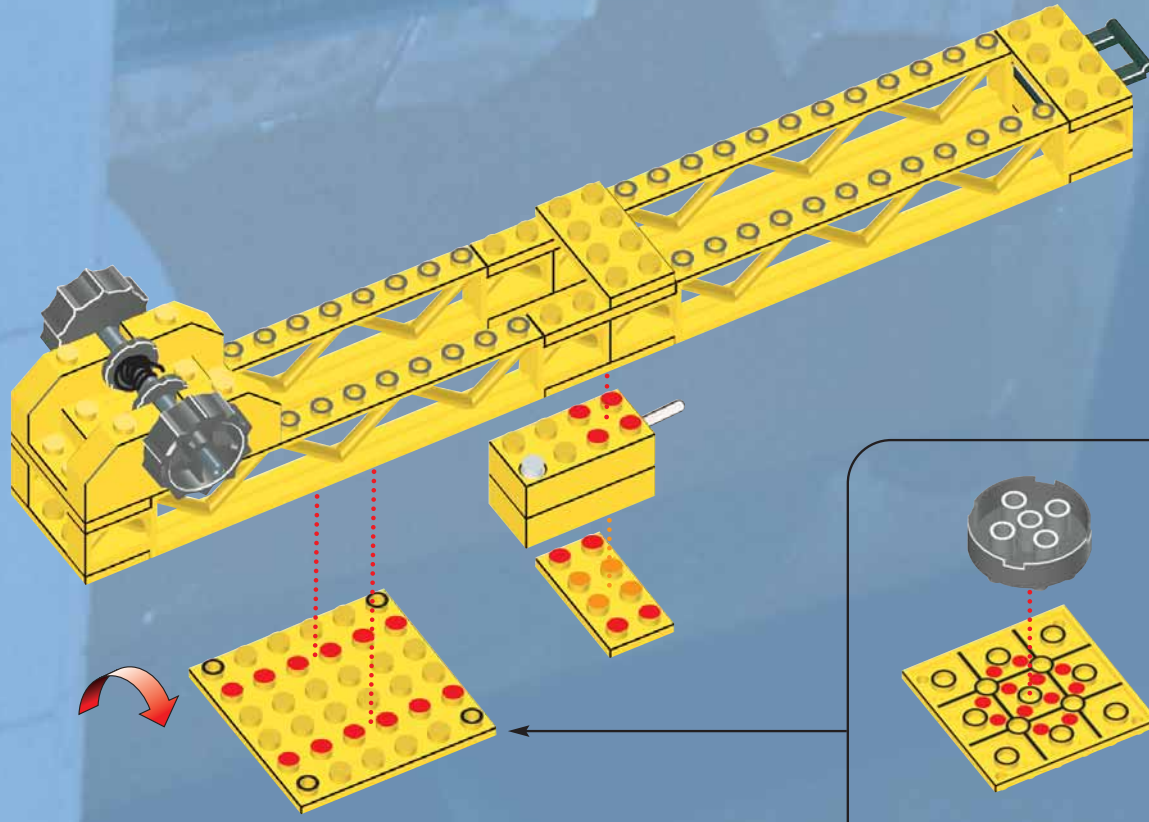

1

2

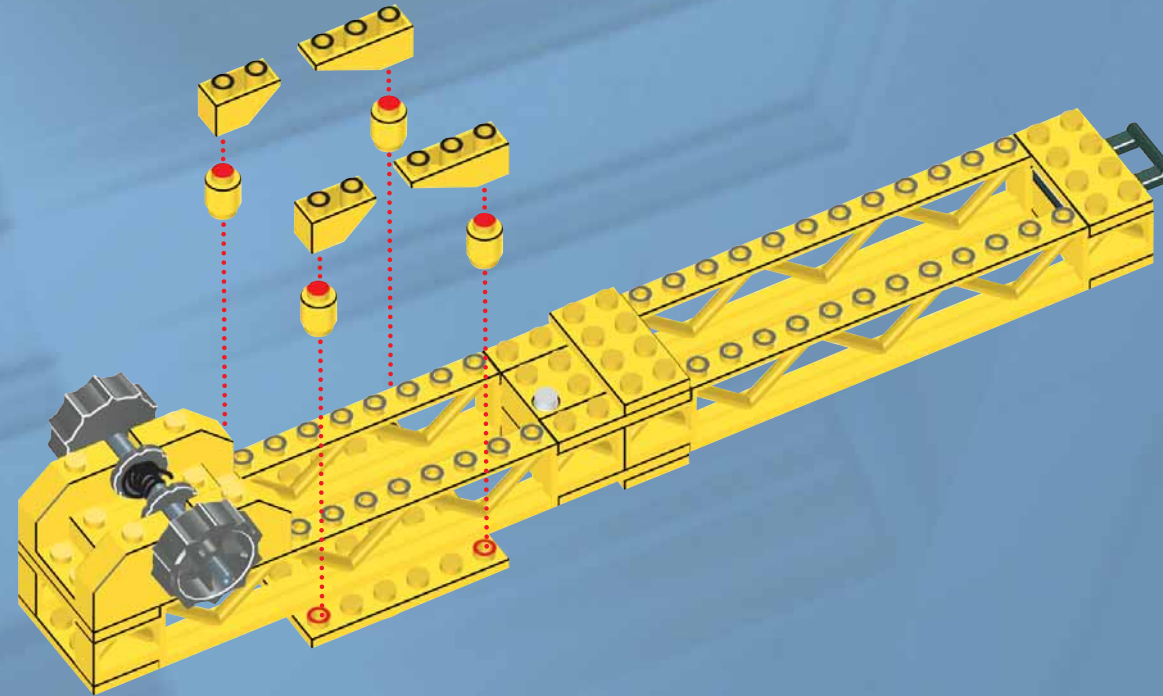

4x

2x

2x





2x

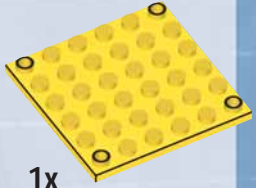

1x

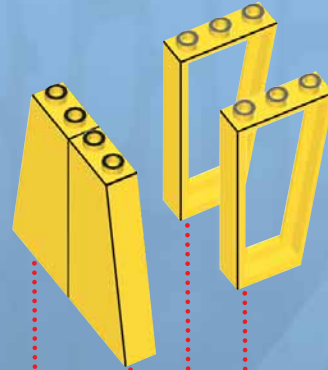
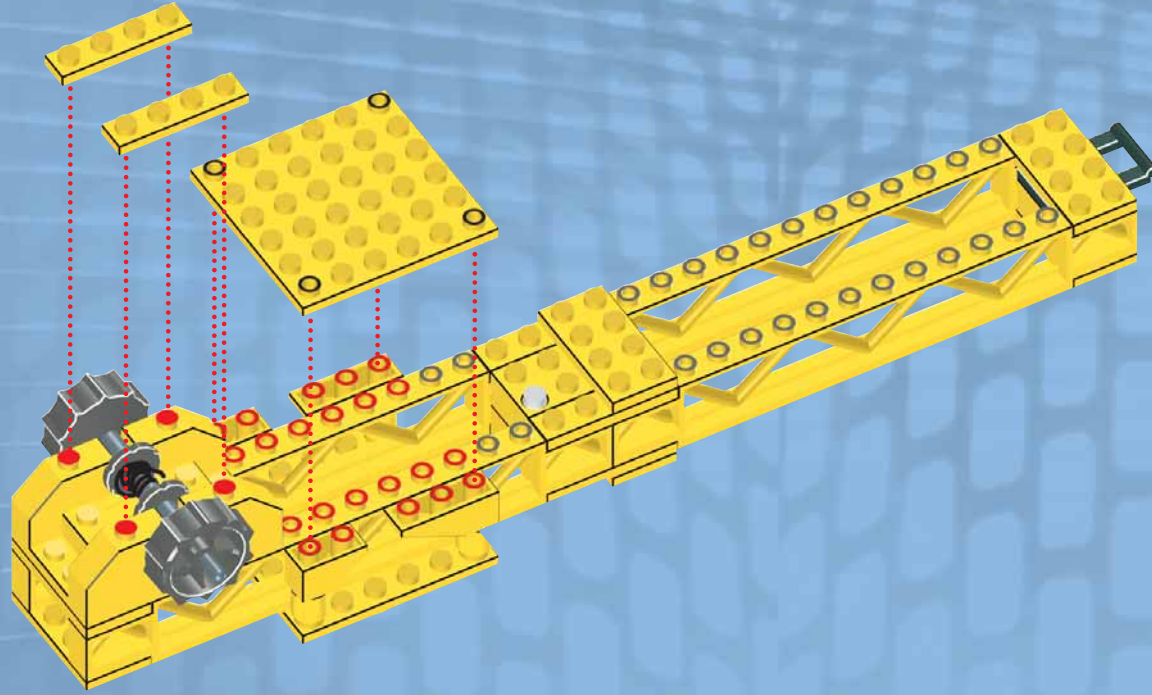

1x



2x



2x

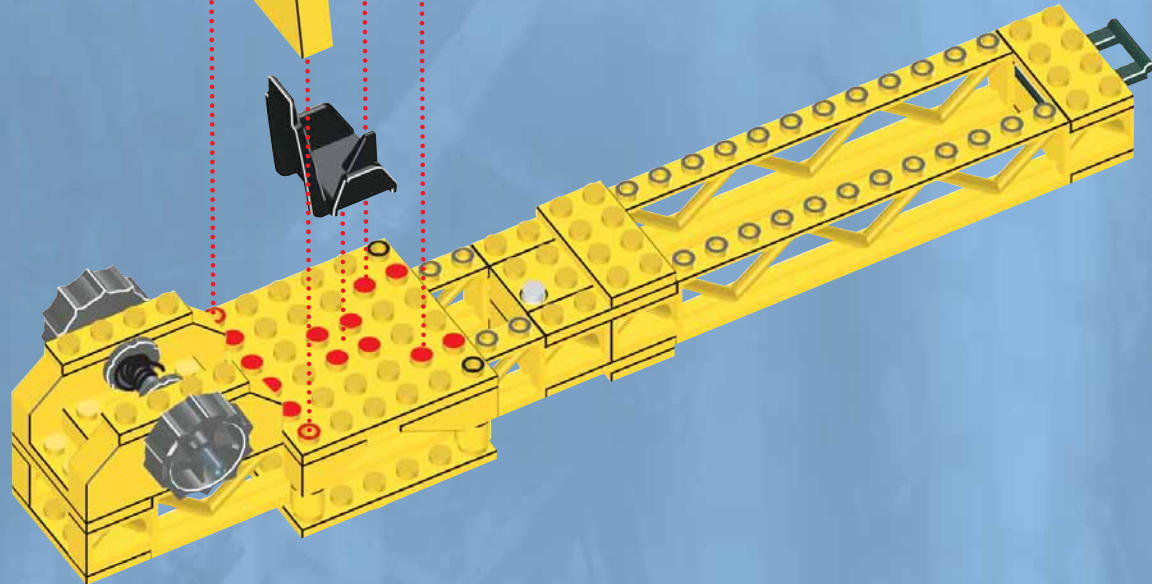



1x

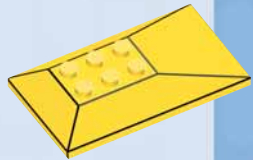

1x

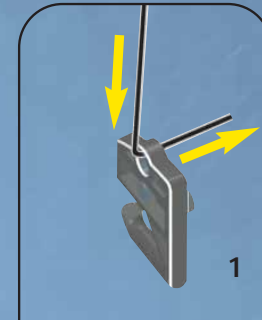
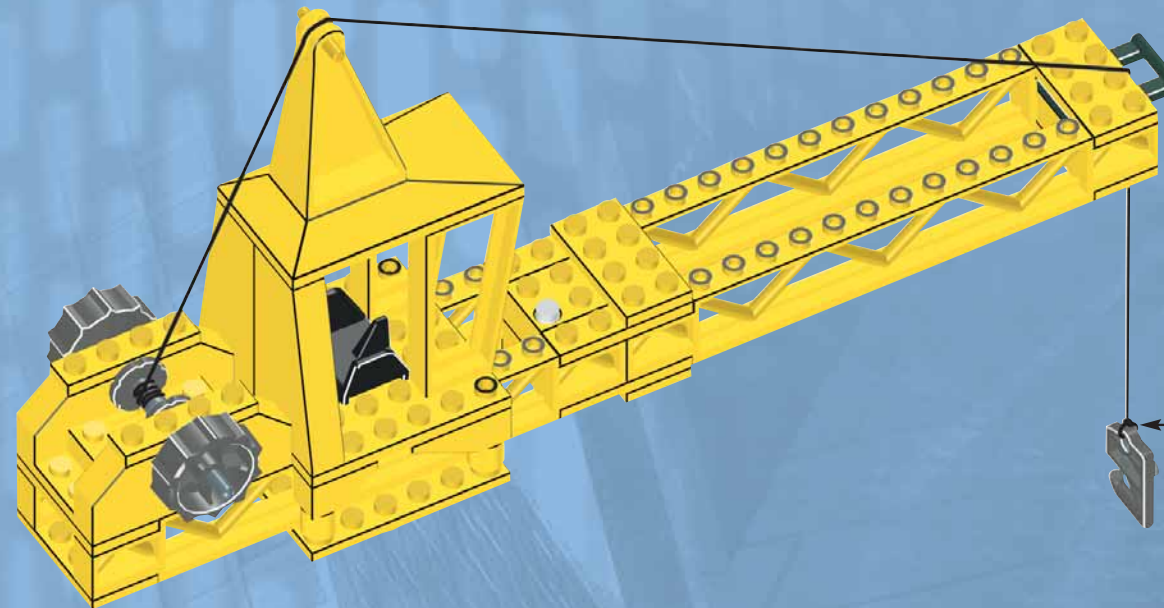
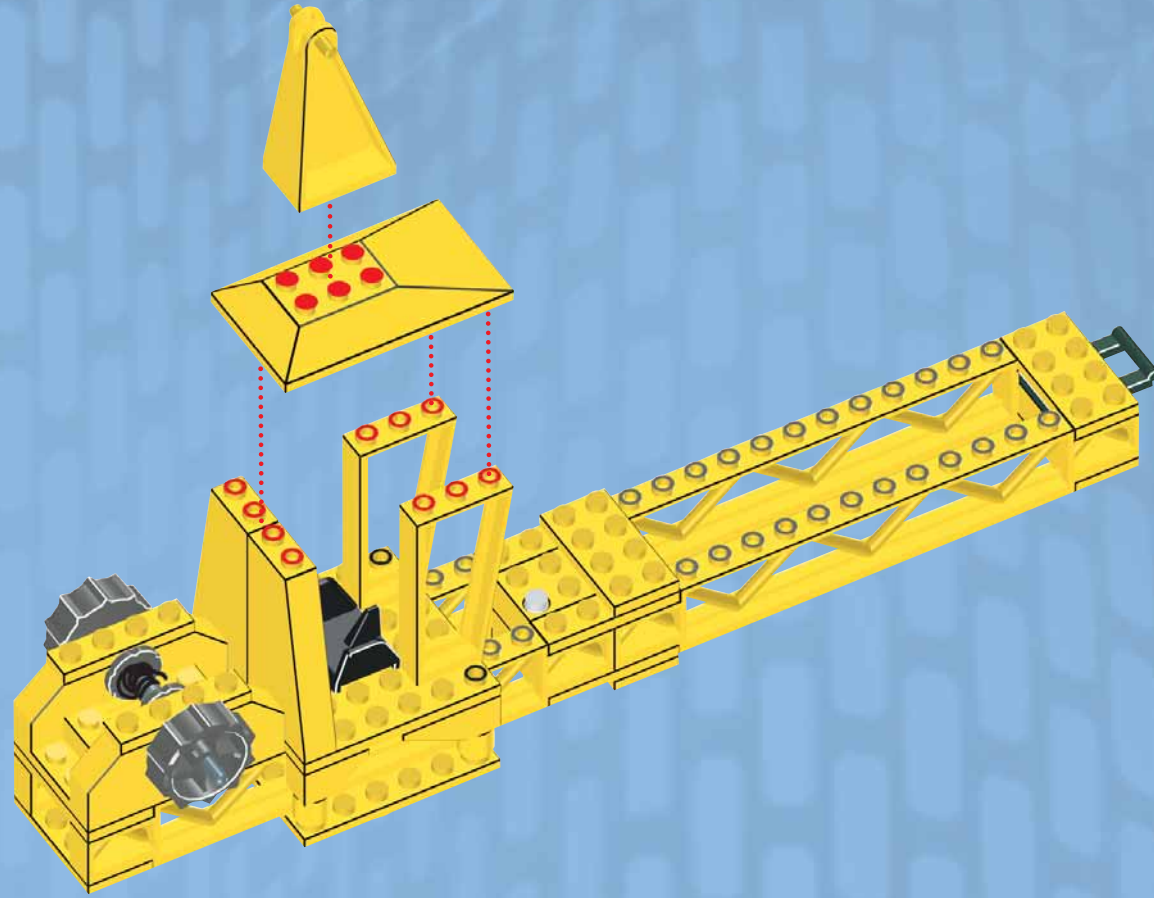

1

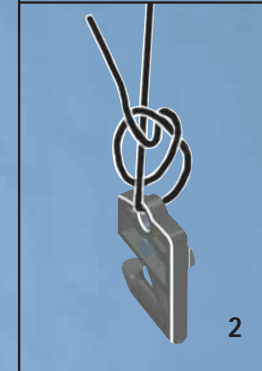

2



3



1x



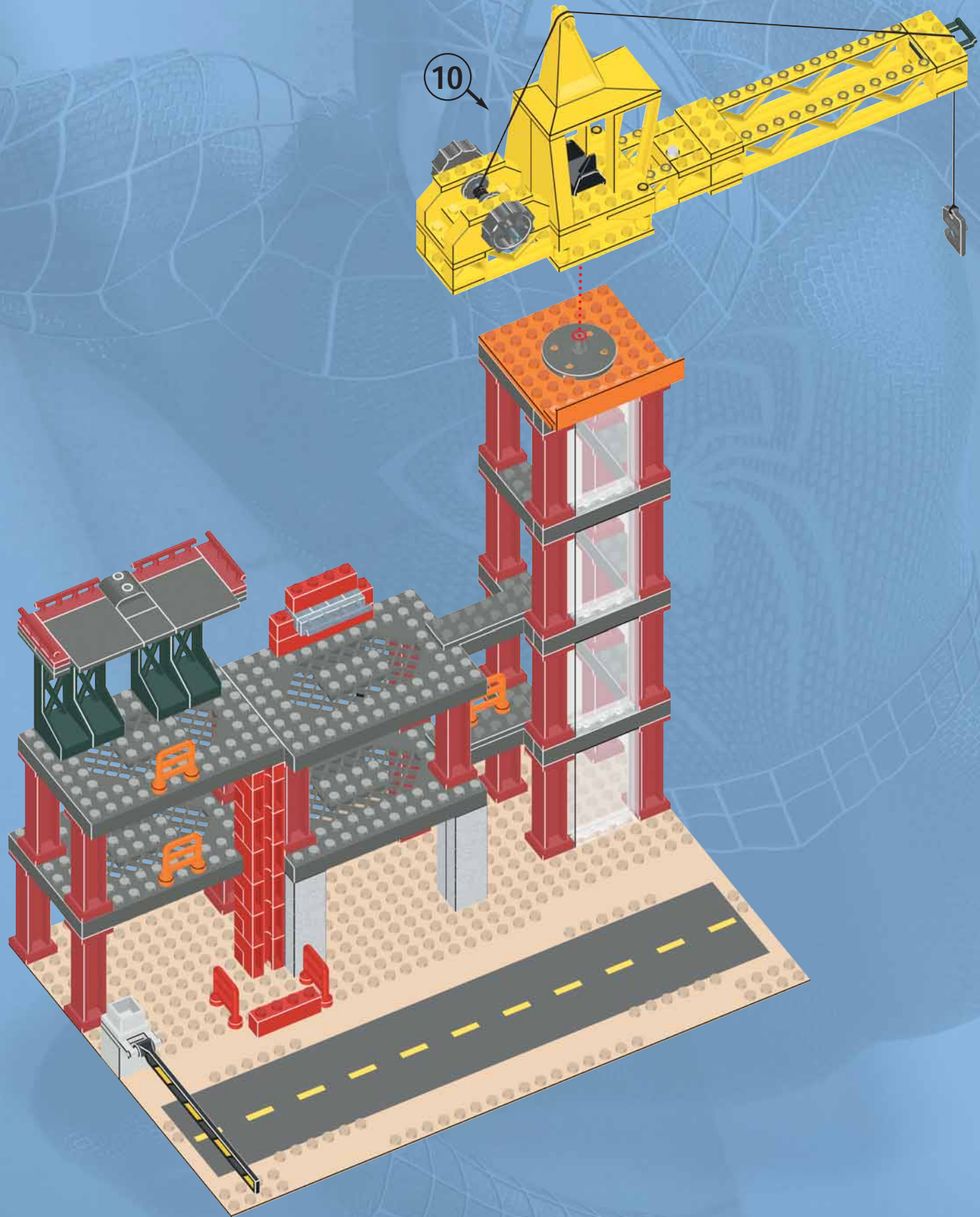



2x

2x

1x

2x

1x

2x

2x

1x

2x

1x

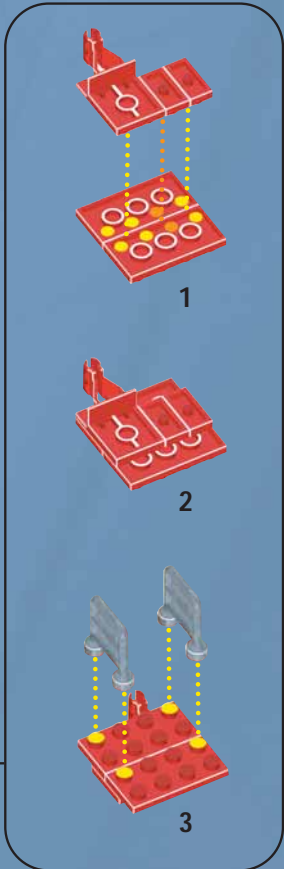
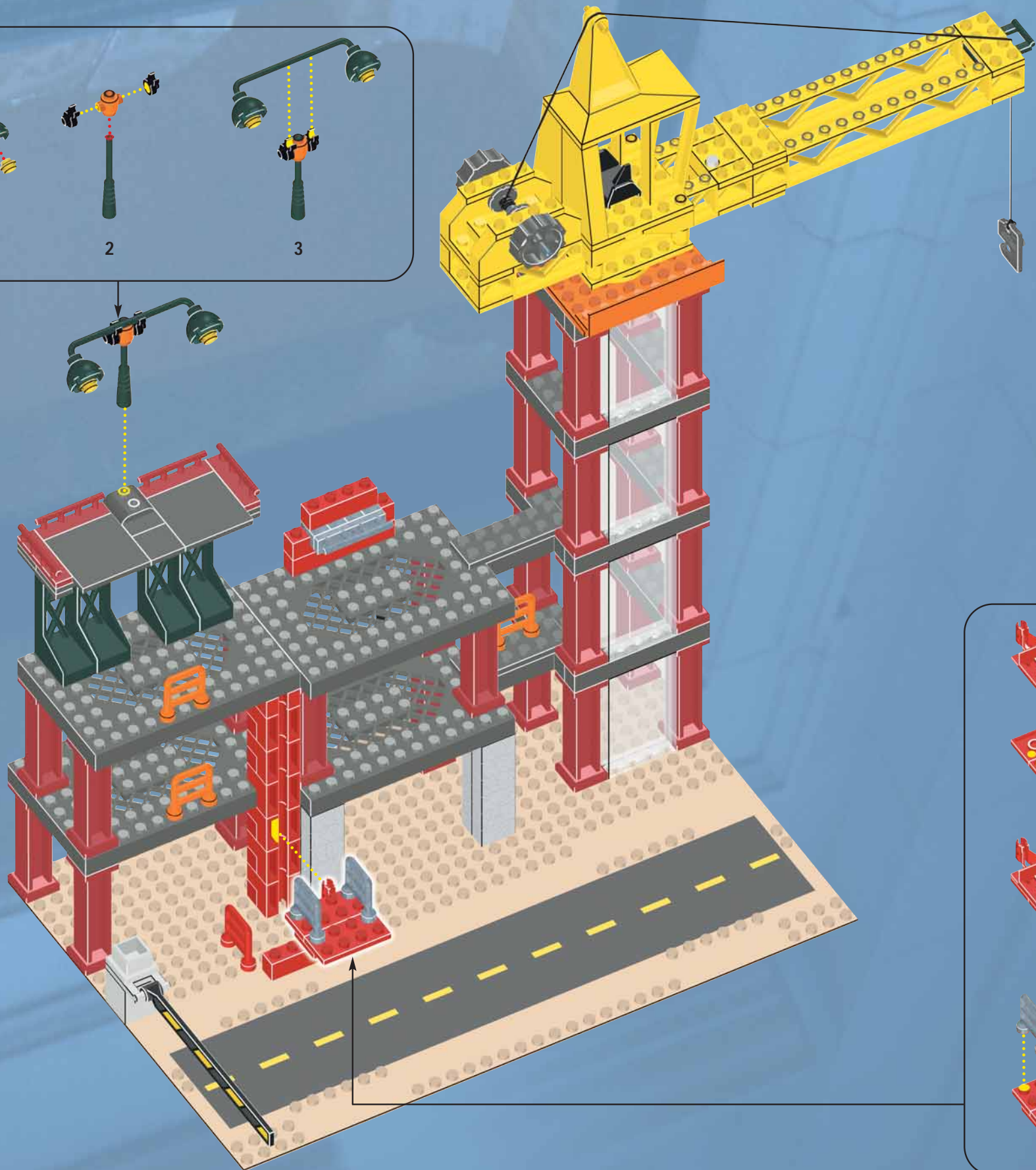
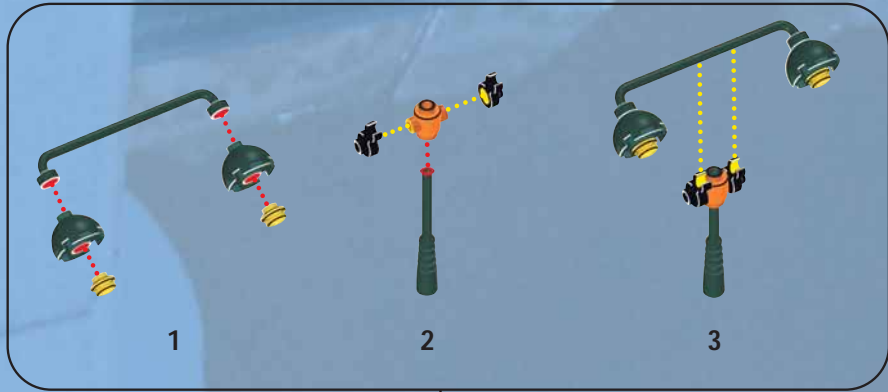

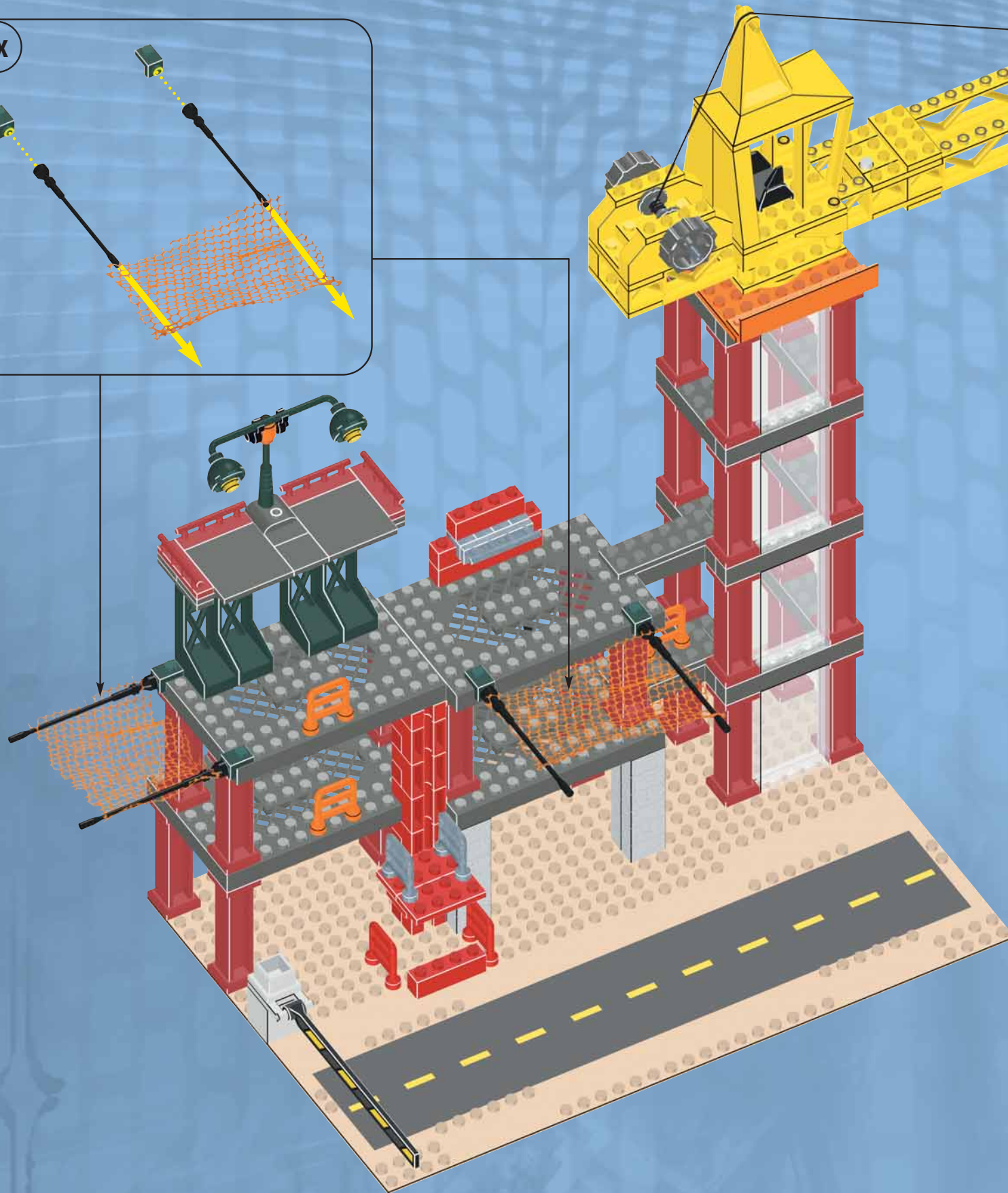
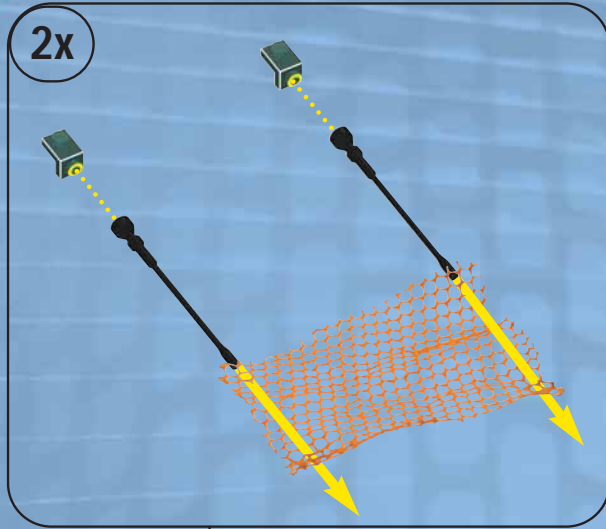

4x



4x

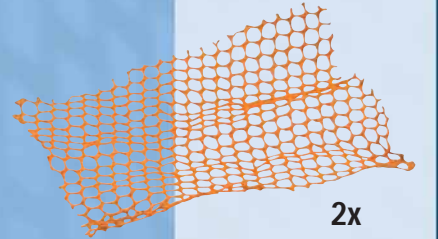

2x



2x

4x

5x

2x

2x

4x

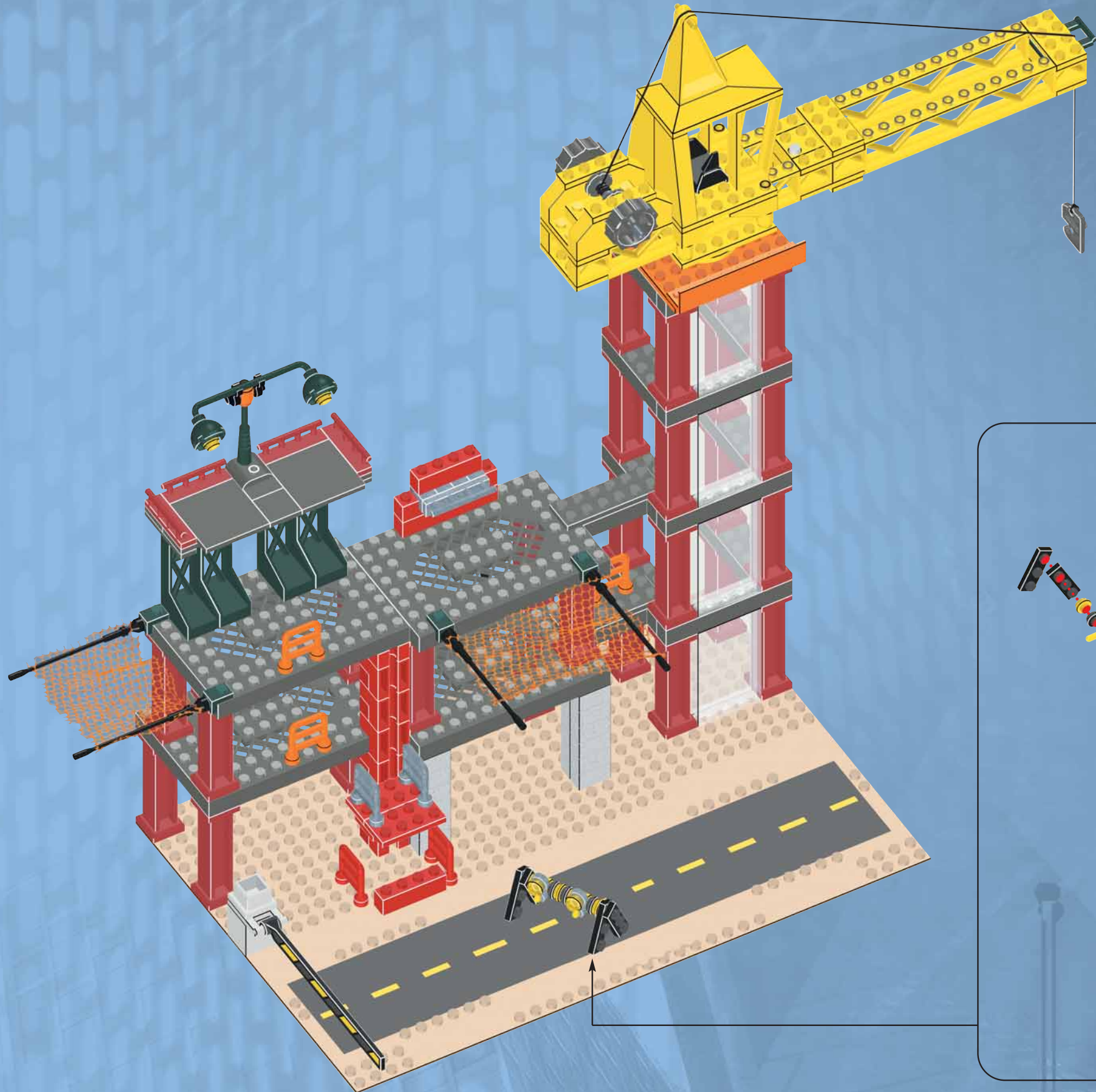

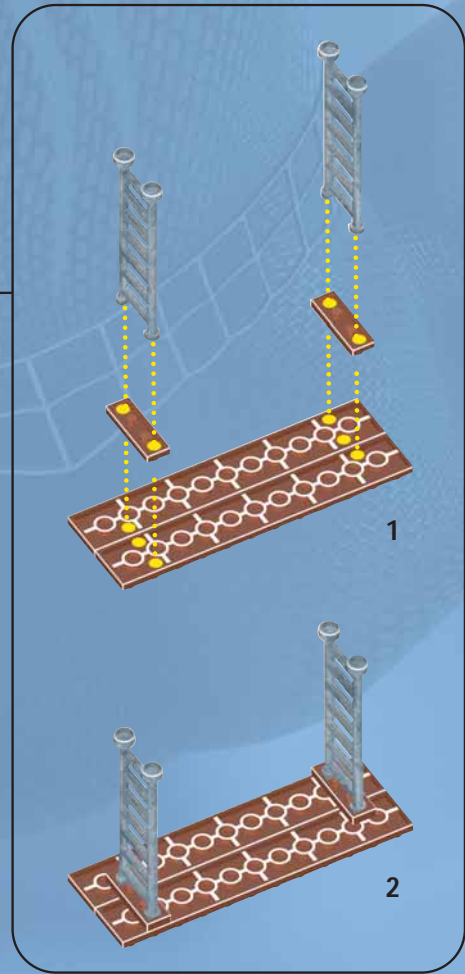
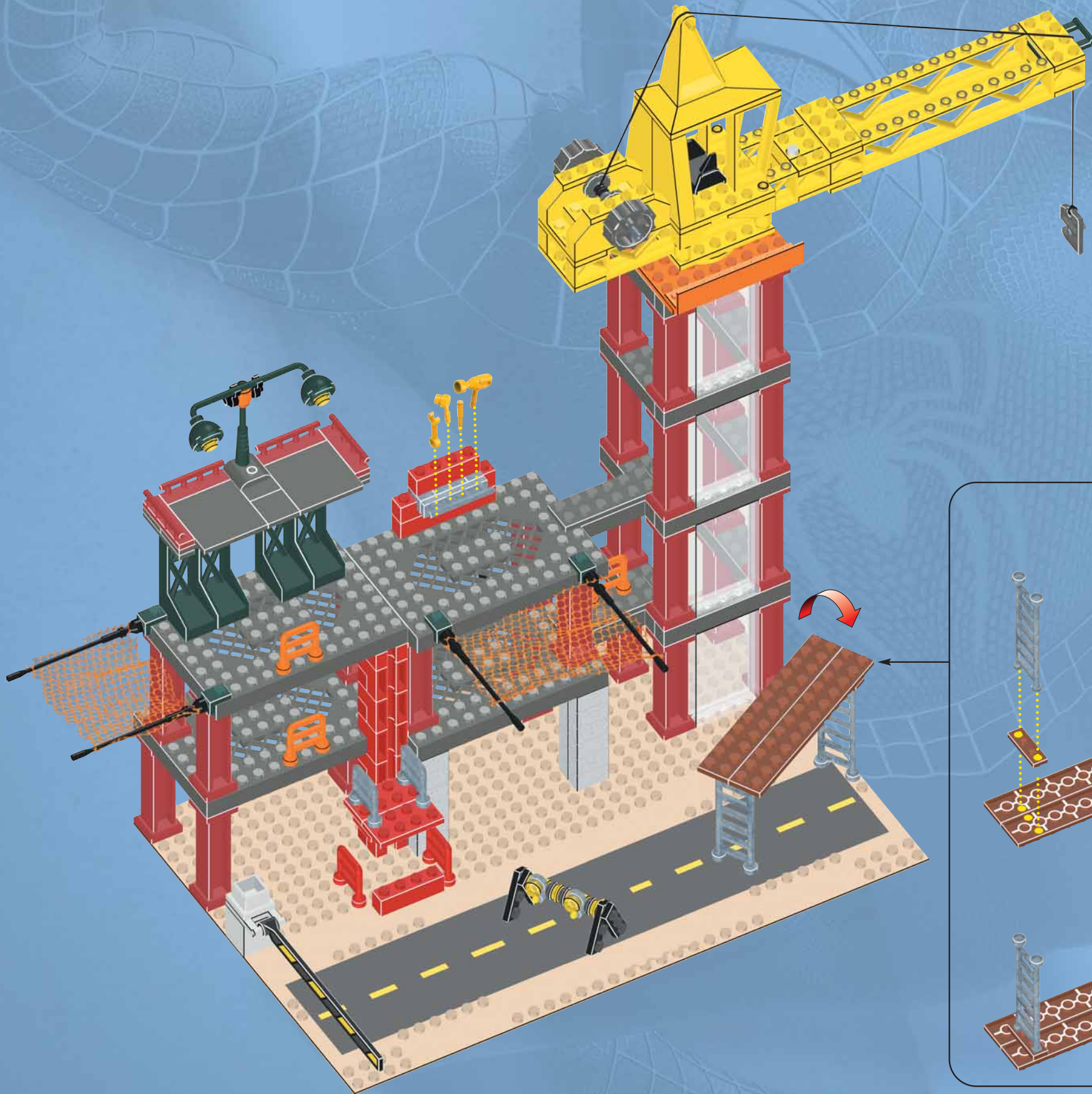

1x



1x



1x



1x



2x



2x



2x



9x

3x

2x

2x

1x

2x

3x

1x

1x

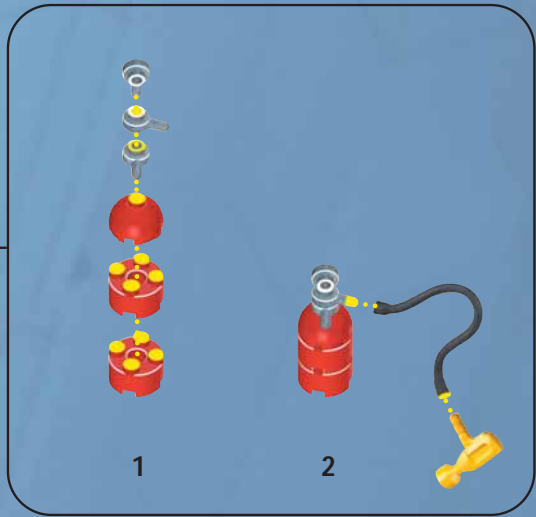
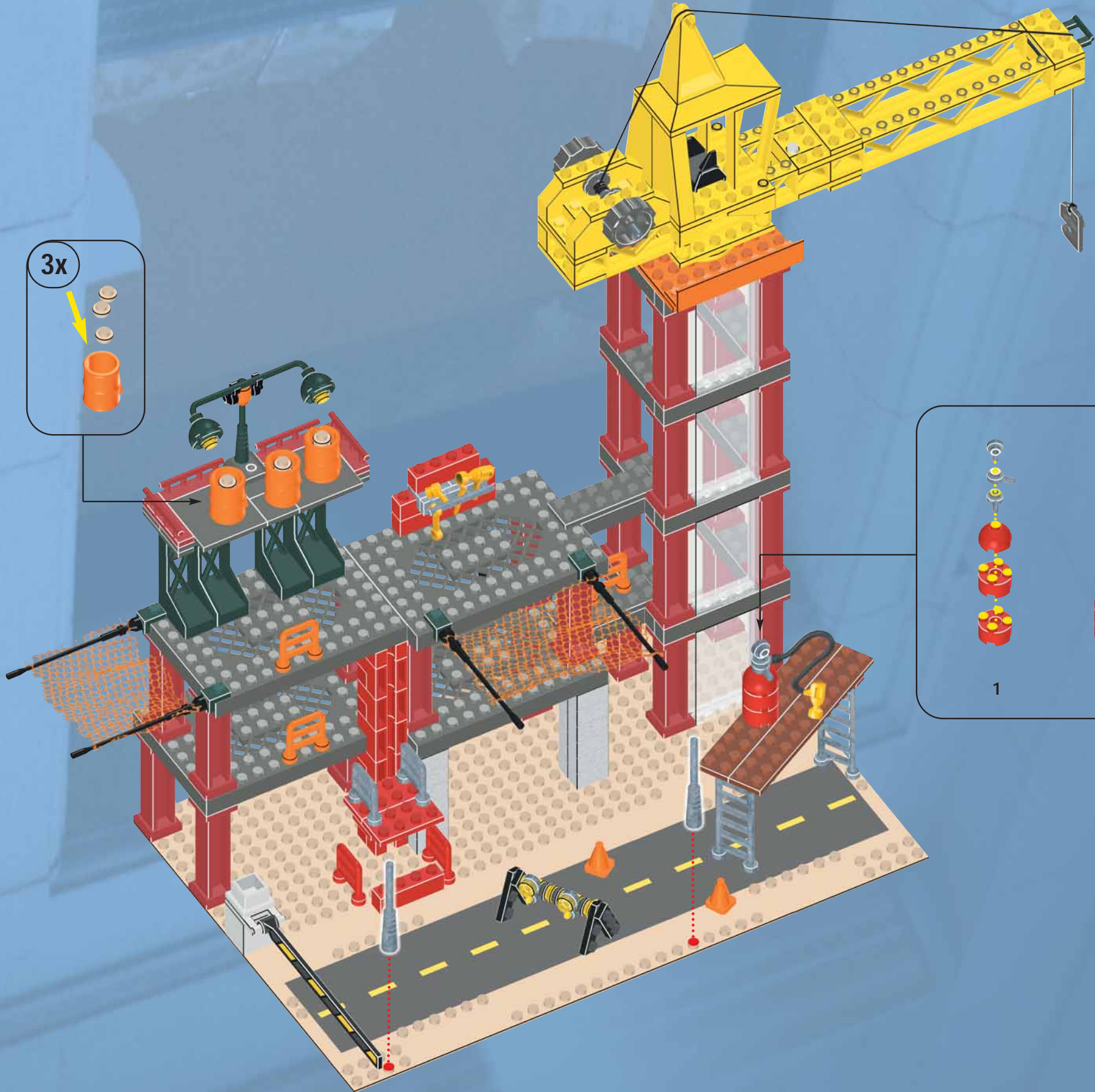

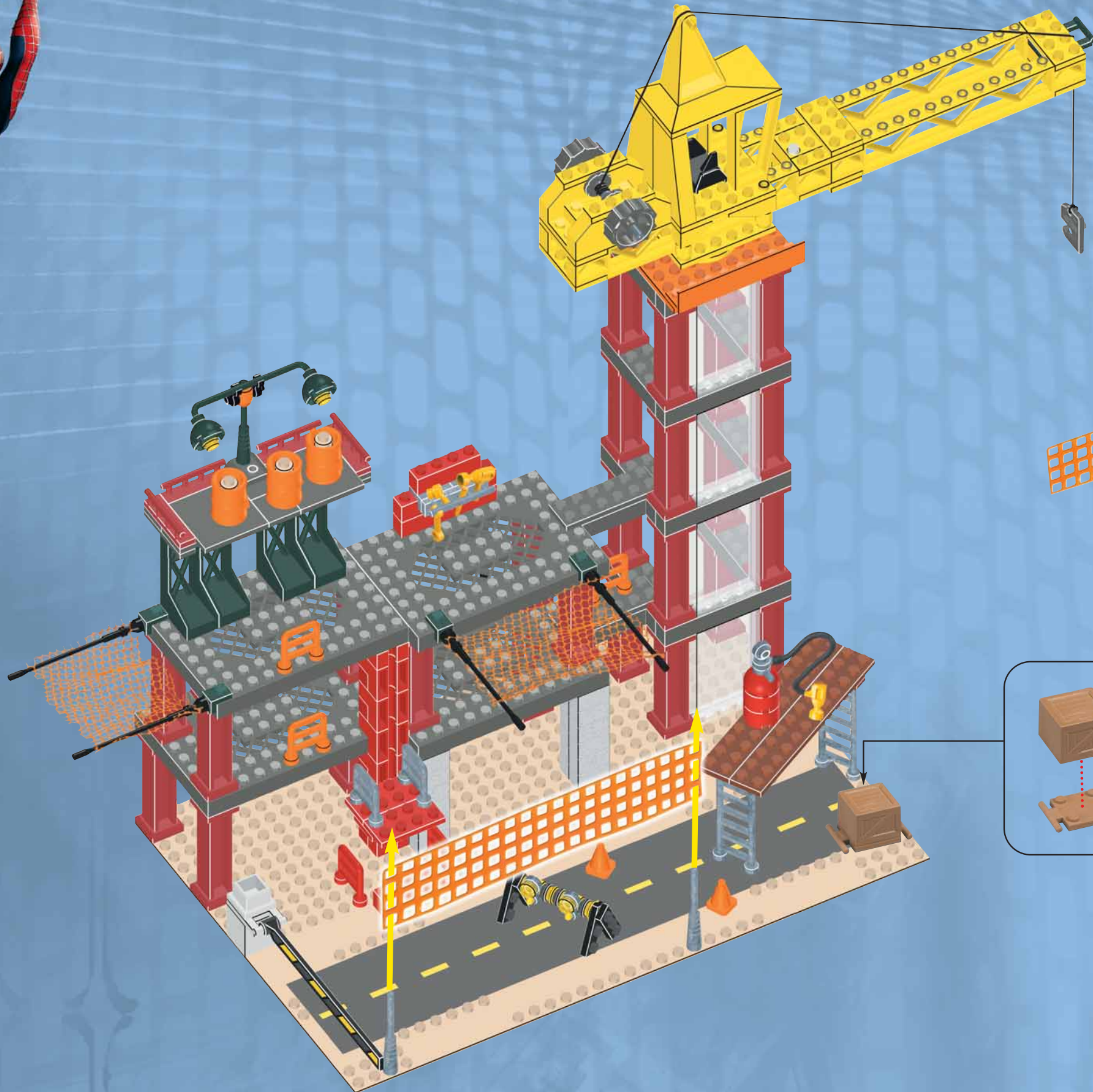

17



1x



1x

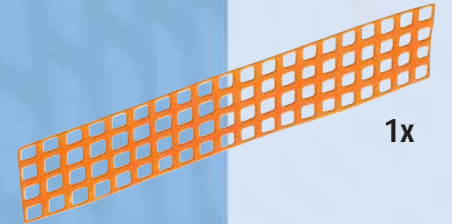

1x

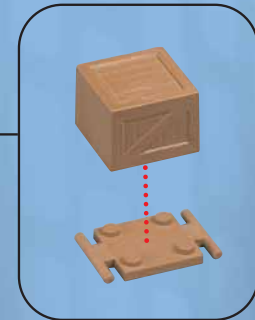



3x



1x

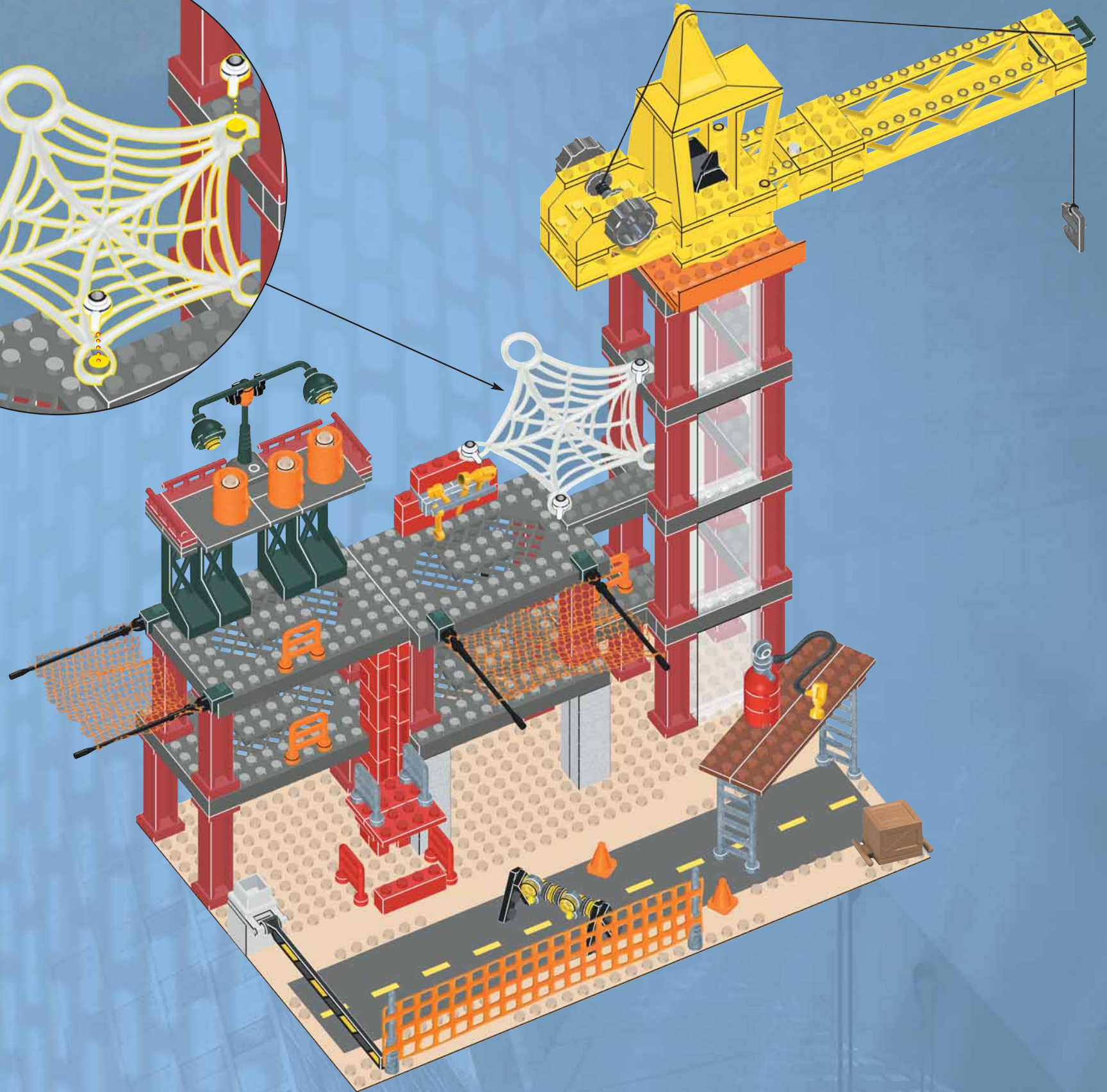
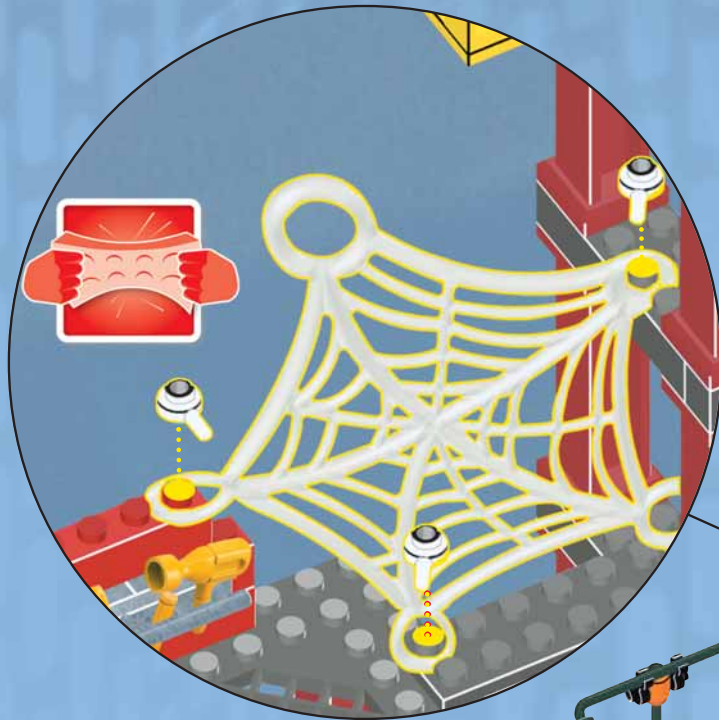

The construction site ultimate battle - the villains attack to demolish Spider-Man®.

La batalla definitiva del lugar de construcción: los malvados atacan para destruir a Spider-Man®.

La bataille ultime du site de construction – les méchants attaquent pour détruire Spider-Man®.

Die Bauplatz-Endschlacht – die Übeltäter greifen an, um Spider-Man® zu erledigen.

De hoogste ruzie op het bouwterrein – de boosdoeners doen een aanval om Spider-Man® te elimineren.

L'ultima battaglia del Cantiere – i cattivi attaccano per demolire Spider-Man®.

A batalha suprema do site de construção – os bandidos atacam para derrubar o Spider-Man®.





FIGURE CHANGES COLOR IN COLD WATER.
 LA FIGURA CAMBIA DE COLOR EN AGUA FRÍA.
 LA FIGURINE CHANGE DE COULEUR DANS L'EAU FROIDE.
 FIGUR ÄNDERT FARBE IN KALTEM WASSER.
 HET FIGUURTJE VERANDERT VAN KLEUR IN KOUD WATER.
 IL PERSONAGGIO CAMBIA COLORE NELL'ACQUA FREDDA.
 A FIGURA MUDA DE COR EM ÁGUA FRIA.





Construction Toy / Juguete de construcción / Jeu de construction /
Konstruktionsspielzeug / Bouwspelgoed / Gioco di costruzioni / Brinquedo de construção

**LIFETIME GUARANTEE / GARANTIZADO DE POR VIDA / GARANTIE À VIE /
LEBENS-LANGE GARANTIE / LEVENSLANGE
GARANTIE / GARANZIA A VITA /
TEM GARANTIA VITALÍCIA**

COMMENTS, QUESTIONS ? / COMENTARIOS, PREGUNTAS ? / COMMENTAIRES,
QUESTIONS ? / KOMMENTARE, FRAGEN ? / COMMENTAAR, VRAGEN ?
COMMENTI?, DOMANDE? / PERGUNTAS?, COMENTARIOS?

1-800-465-MEGA

U.S. & Canada only / Solamente en EEUU y Canadá / É.U. et Canada
seulement / Nur für U.S. und Kanada / Uitsluitend in de V.S. en Canada /
USA e Canada solamente / Somente EE.UU. e Canadá

www.megabloks.com



© 2007, MEGA Brands Inc.
MEGA Brands Inc. and the MEGA Brands Inc. logo are registered trademarks of MEGA Brands Inc. / MEGA Brands Inc. y el logotipo MEGA Brands Inc. son marcas registradas de MEGA Brands Inc. / MEGA Brands Inc. et le logo de
MEGA Brands Inc. sont des marques de commerce déposées de MEGA Brands Inc. / MEGA Brands Inc. und das MEGA Brands Inc.-Logo sind eingetragene Warenzeichen von MEGA Brands Inc. / MEGA Brands Inc. en het MEGA Brands
Inc. logo zijn gedeponeerde handelsmerken van MEGA Brands Inc. / MEGA Brands Inc. ed il logo di MEGA Brands Inc. sono marchi di fabbrica di MEGA Brands Inc. / MEGA Brands Inc. e o logo MEGA Brands Inc. são marcas
registradas de MEGA Brands Inc.

Printed in China AD020051A