



**building
bigger
thinking™**



WARNING: CHOKING HAZARD.
Toy contains small parts and a small ball.
Not for children under 3 years.

10405

LEGO

A close-up of a LEGO Technic duck head. The duck is primarily purple, with a yellow beak and a yellow curved horn-like structure on top. It has large white eyes with black pupils. The duck is constructed from various Technic bricks and pins, including a blue base. The background is a solid bright yellow.

**building
bigger
thinking™**

Did you know your
**imagination is bigger
than a grown-up?**

Savais-tu que ton **imagination**
est **plus grande que celle
des adultes ?**

¿Sabías que tienes más
imaginación que los
adultos?

it's true! you can
think of anything...
all you need to do is **build it**

c'est vrai !
tu peux **imaginer tout ce que tu veux...**
et t'amuser à **le construire**

¡es cierto!
puedes **imaginar cualquier cosa...**
lo único que tienes que hacer es
construir



LEGO

For **60 years**
LEGO® bricks have
inspired **creativity**

Depuis **60 ans**,
les briques LEGO®
stimulent la **créativité**

Los bricks LEGO®
llevan más de **60**
años fomentando la
creatividad

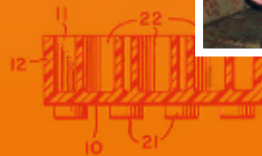



This box is
designed to inspire
bigger thinking in
generations to come



Cette boîte est
conçue pour inspirer les
générations futures à
voir plus grand

Esta caja está
diseñada para inspirar
a las próximas
generaciones a
pensar en grande

Easy Building
Construction facile
Construcción fácil

Medium Building
Construction intermédiaire
Construcción intermedia

Advanced Building
Construction avancée
Construcción avanzada



Page/Página **46**



Page/Página **22**



how can

travel **through**
time?

comment les

peuvent voyager
dans le temps ?

¿cómo puede

viajar **a través**
del tiempo?



Page/Página **32**



Page/Página **8**

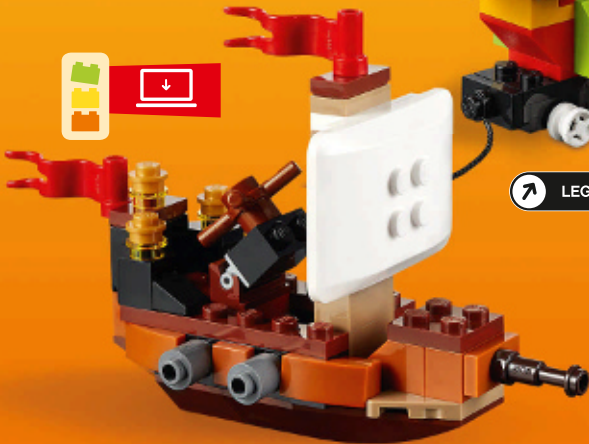

 [LEGO.com/biggerthinking](https://www.lego.com/biggerthinking)



AVERTISSEMENT : RISQUE D'ÉTOUFFEMENT.
Le jouet contient des petites pièces ainsi qu'une petite boule.
Il ne convient pas aux enfants de moins de 3 ans.



ADVERTENCIA: PELIGRO DE ASFIXIA.
Juguete que contiene partes pequeñas y una pelota pequeña.
No recomendado para niños menores de 3 años.

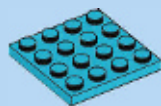

1x

1

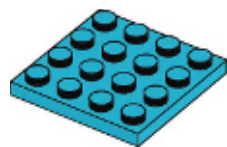

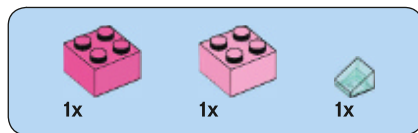

2

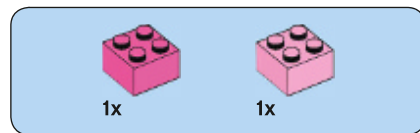
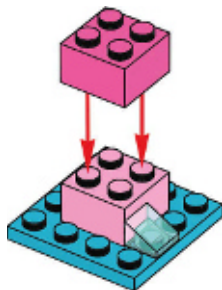

3

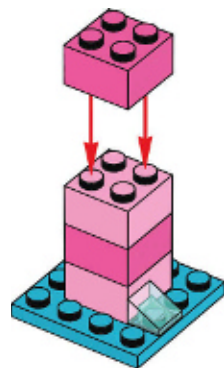



1x

4



1x

5

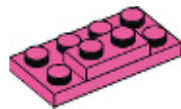



1x

6

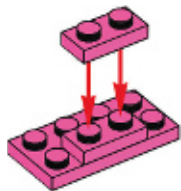

2x

7

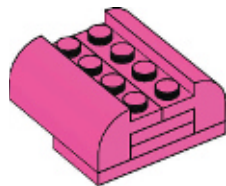

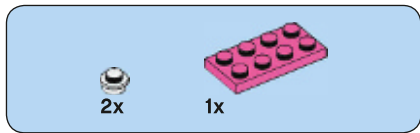

8

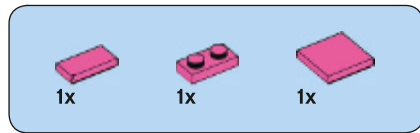
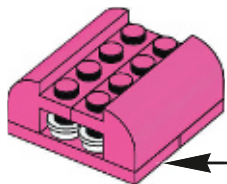
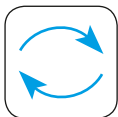
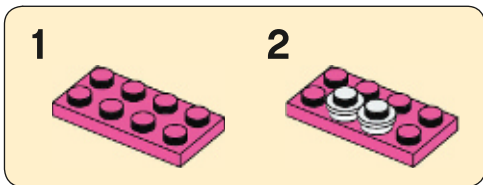

9

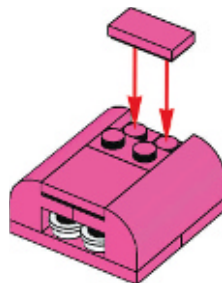



10

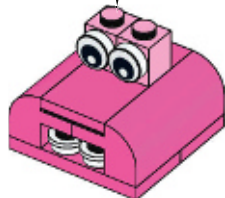
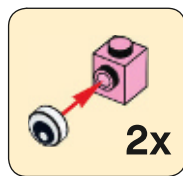

11

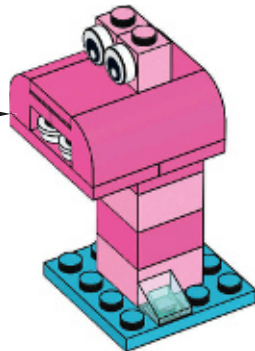



2x

12

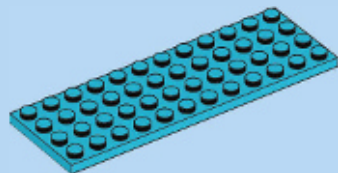
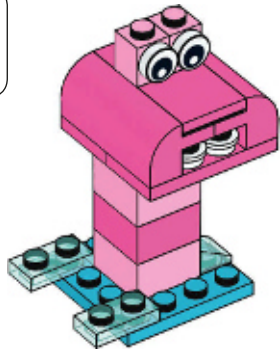
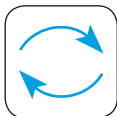

1x

13

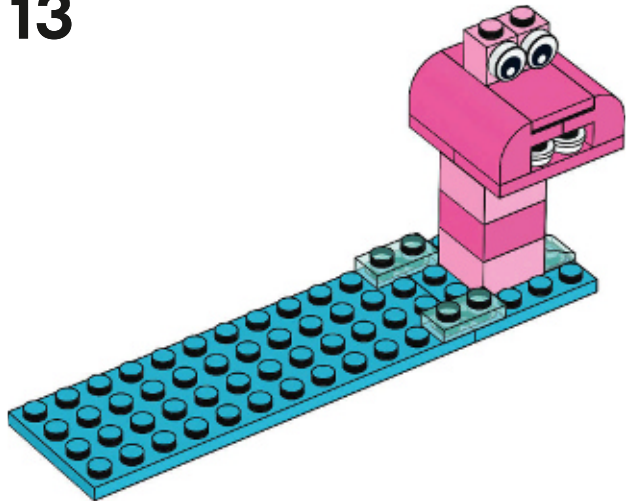



1x

14

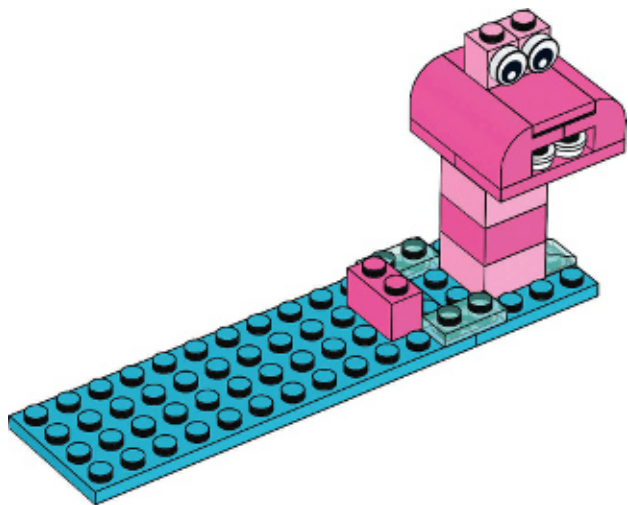

2x

15

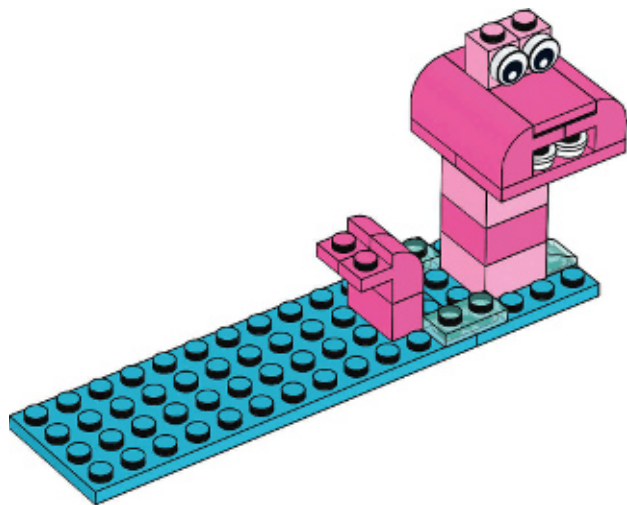



1x



2x

16

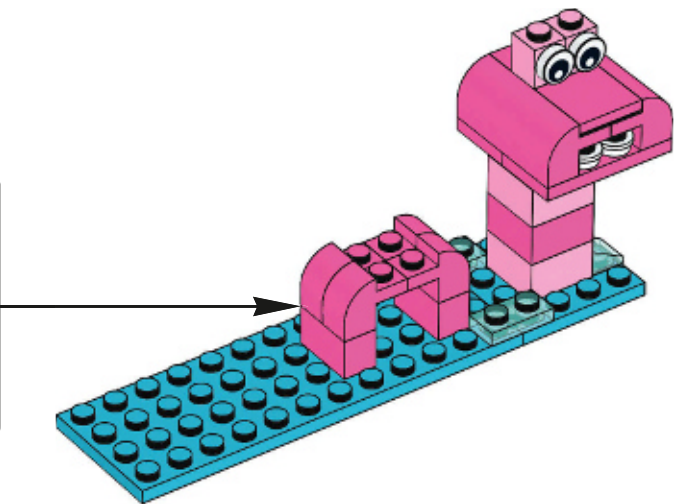
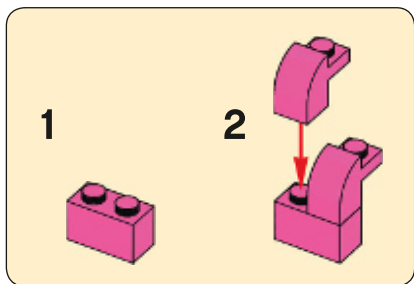



1x

17

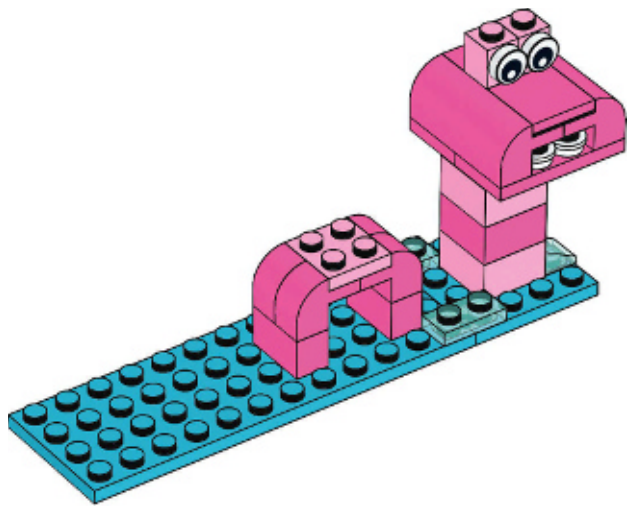

4x

18

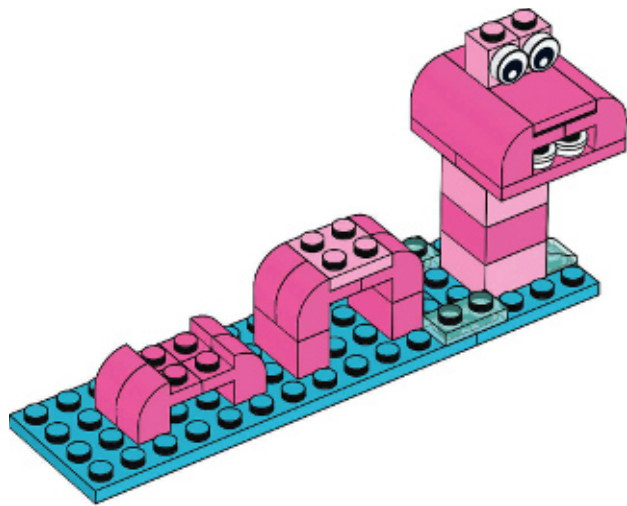



1x

19

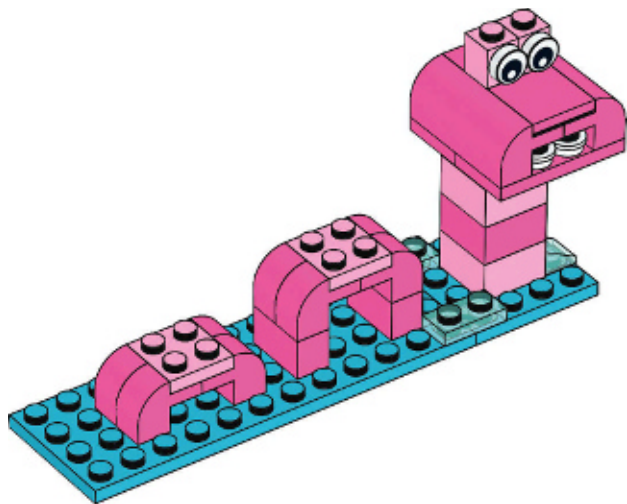

18



1x

20

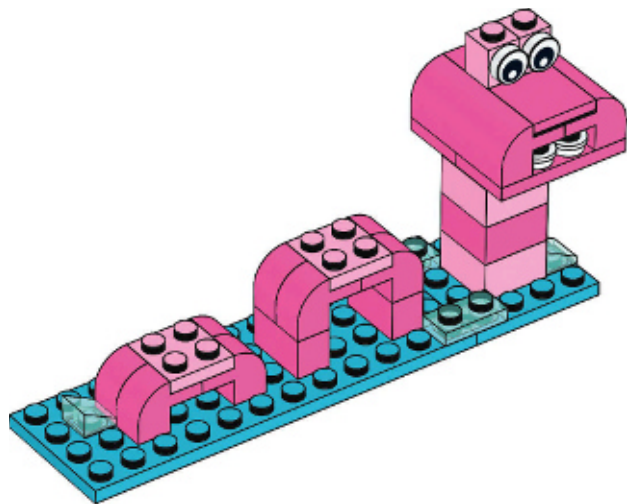



2x

21

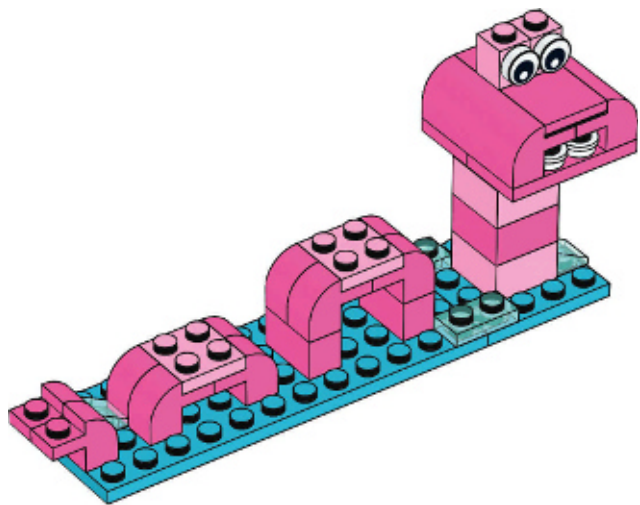

1x

22

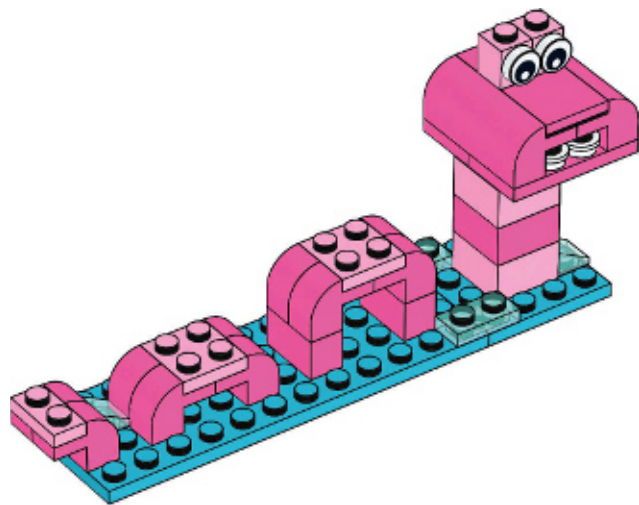



5x

23

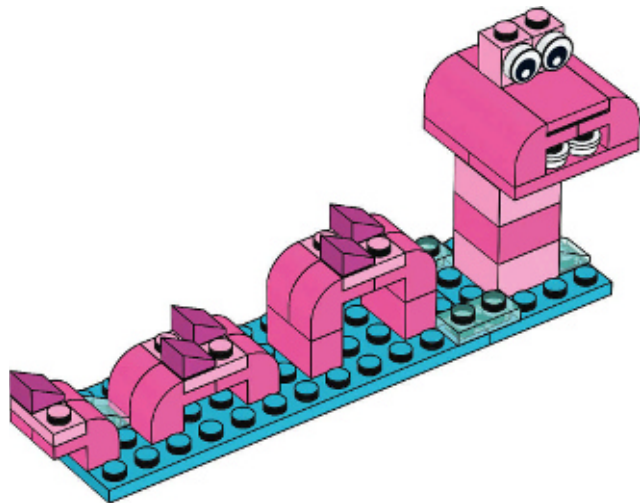

who
discovered the

..... ? 

qui
a découvert

..... ? 

¿quién
descubrió

..... ? 



Upload your build at / Télécharge ta construction sur / Carga tu modelo en



 [LEGO.com/biggerthinking](https://www.lego.com/biggerthinking)



1x

1





1x



1x

2



1x

3



1x

4

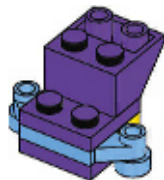



2x

5

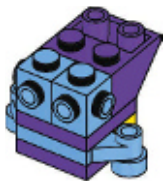

1x

6





7

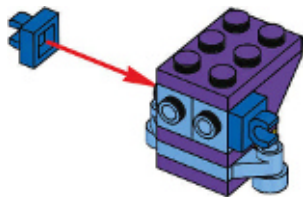

8

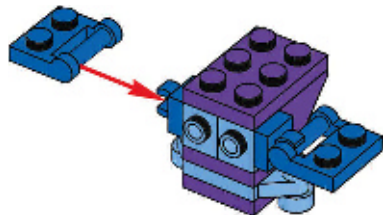

9

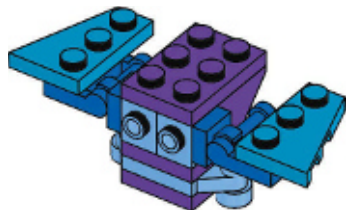



10



11

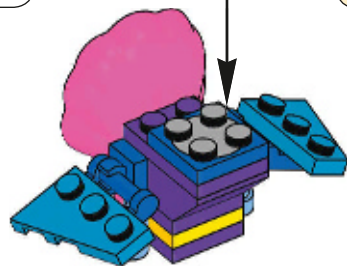
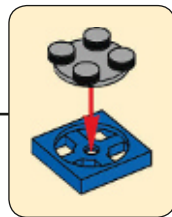
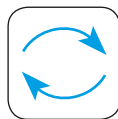



12

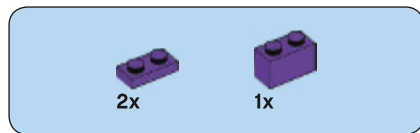
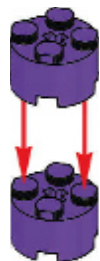

13

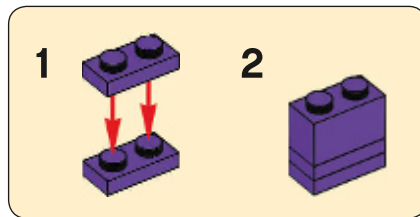



1x

14

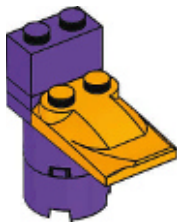

2x



2x

15

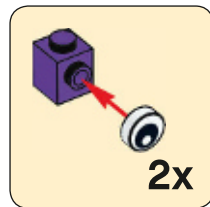

2x





1x



1x

16

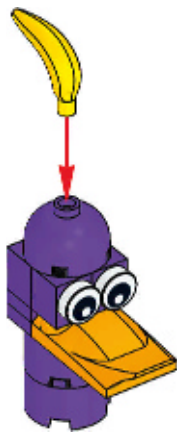

17

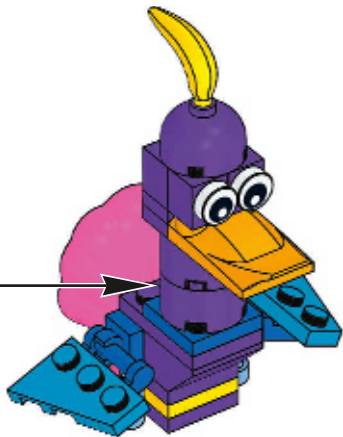



2x

18

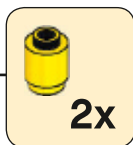
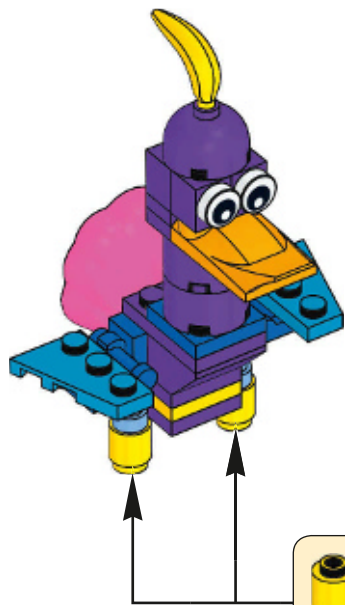

2x



1x



1x

19

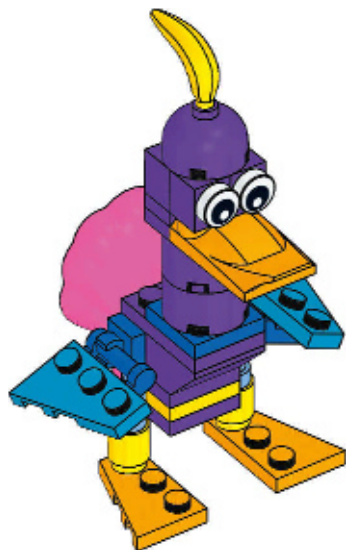

what is

..... 

hidden **talent?**

quel talent
caché possède

..... ? 

¿cuál es el talento
desconocido de

..... ? 



Upload your build at / Télécharge ta construction sur / Carga tu modelo en



 [LEGO.com/biggerthinking](https://www.lego.com/biggerthinking)

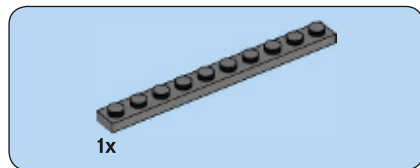

1x

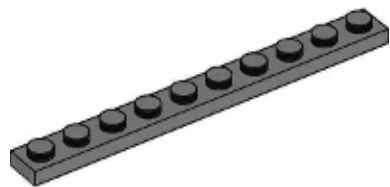



2

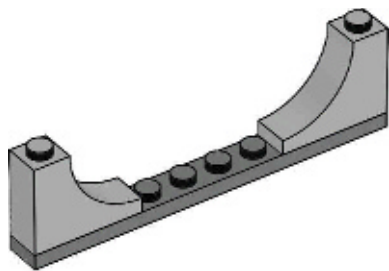

3

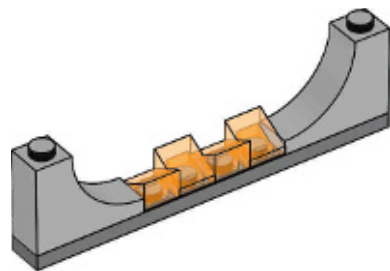



2x

4

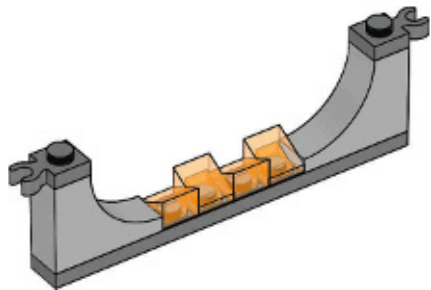

2x

5

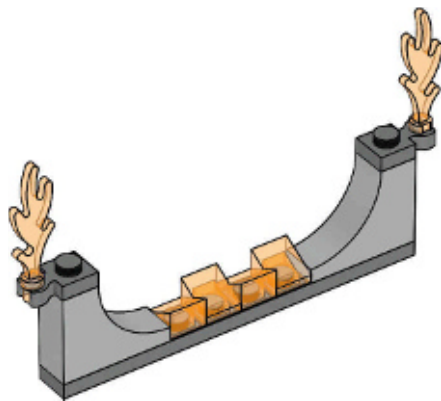



2x

6

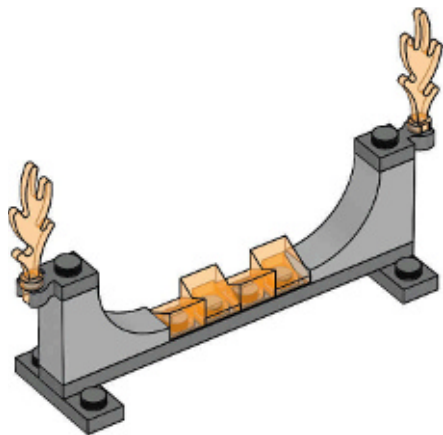

4x

7

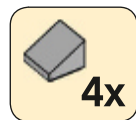

4x

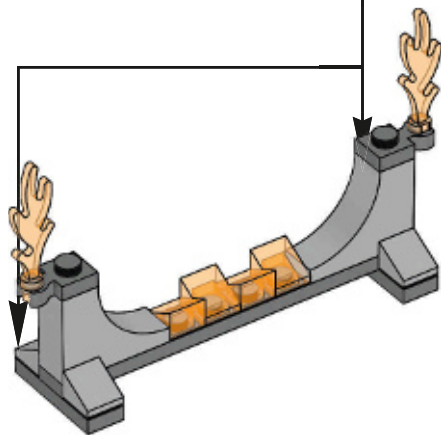

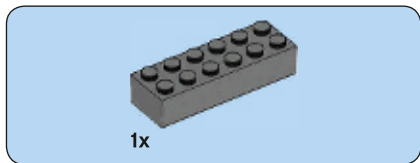

1



2



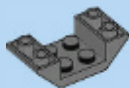

1x

3

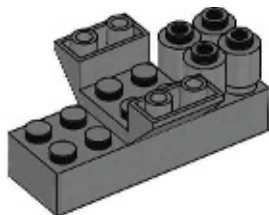

4x

4

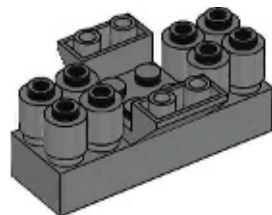

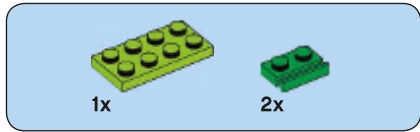

5

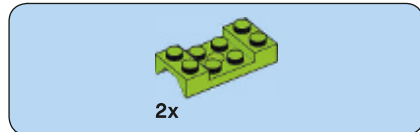
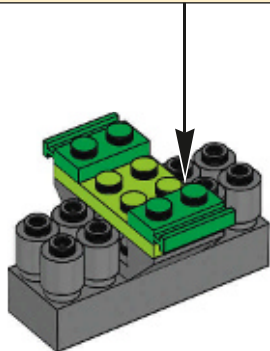
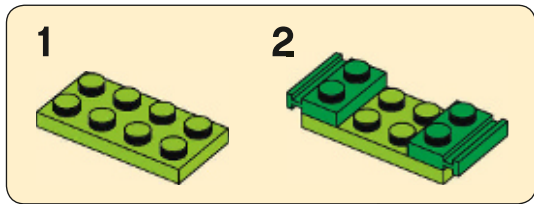

6

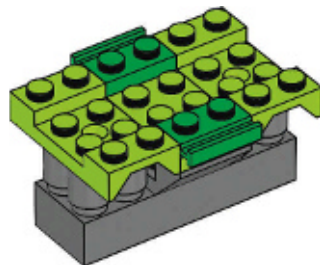

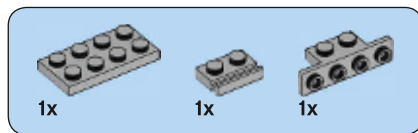

7

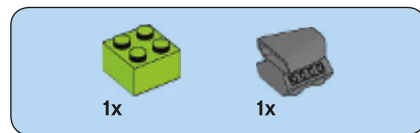
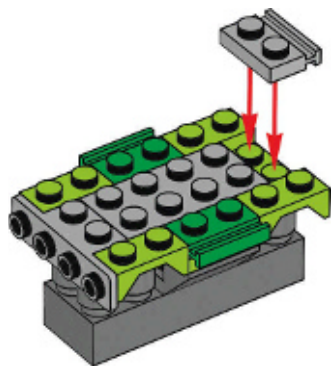

8

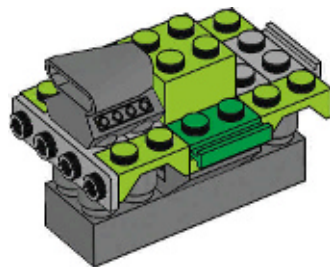



2x



4x

9

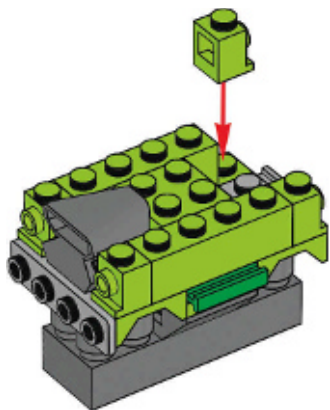

40



2x



2x

10

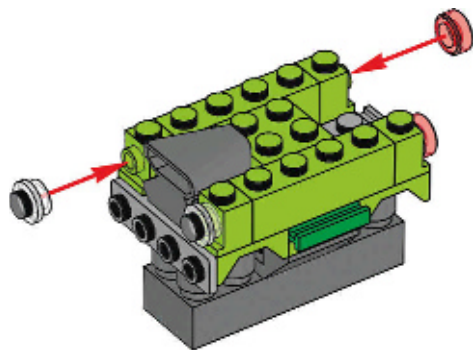



1x



1x

11

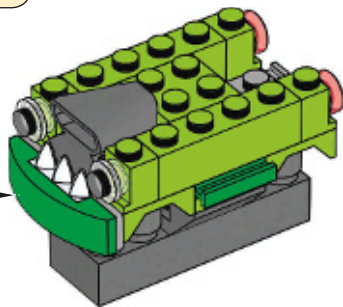
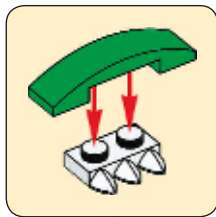

2x

12

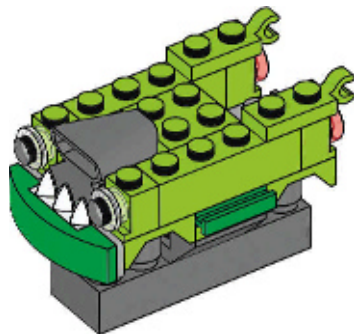



2x



1x

13

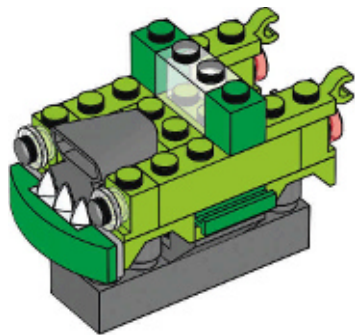

2x

14

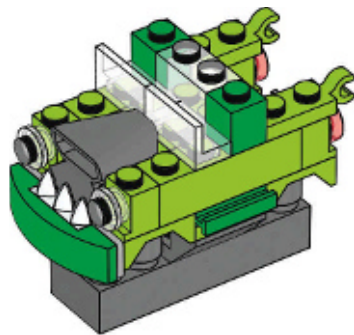

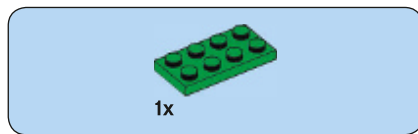

15

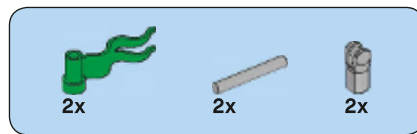
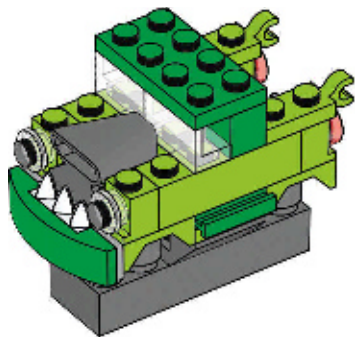

16

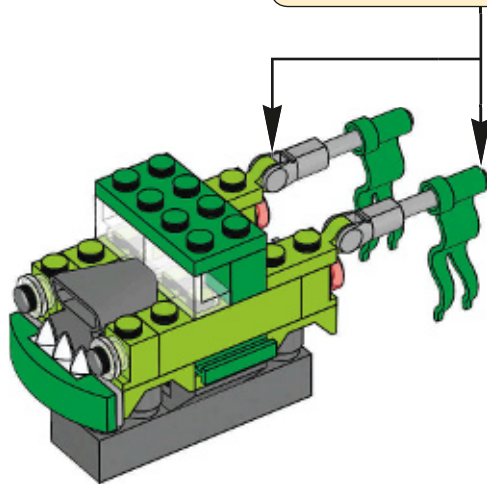
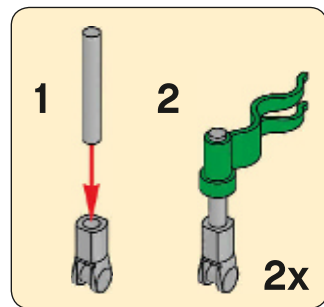



2x

17



4x



4x

18

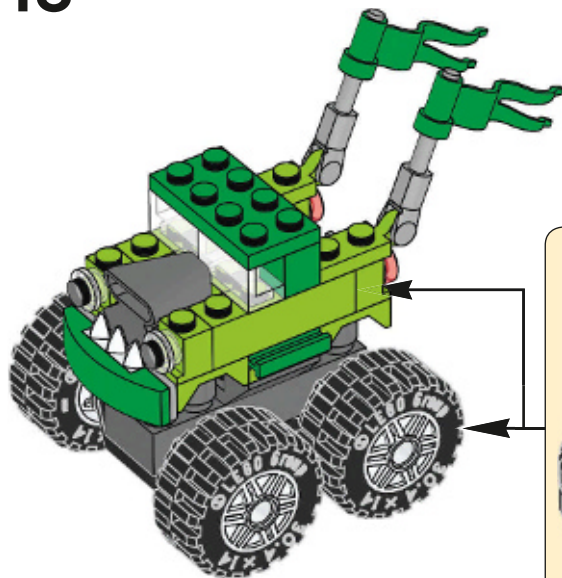

4x

which

is winning the
race to Mars?

lequel des

va remporter la
course vers Mars ?

¿qué

está ganando la
carrera a Marte?

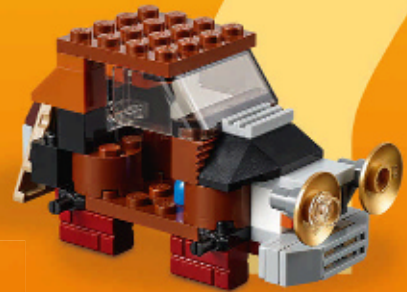

Upload your build at / Télécharge ta construction sur / Carga tu modelo en



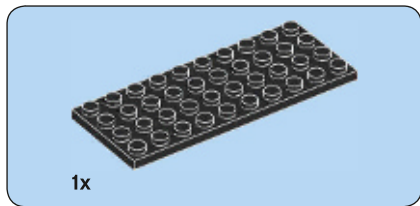
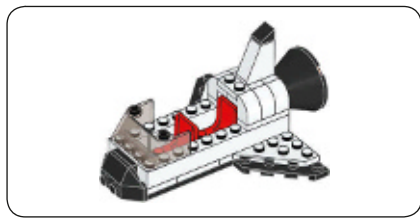

1

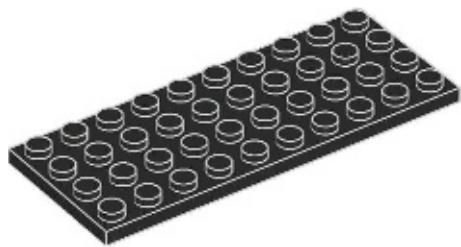



1x

2

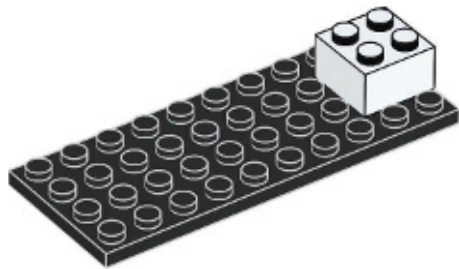

2x

3

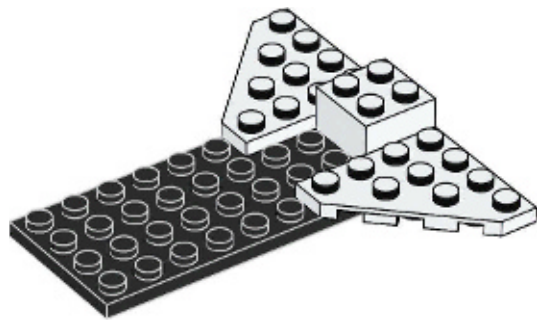



2x

4

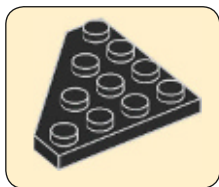

2x

5

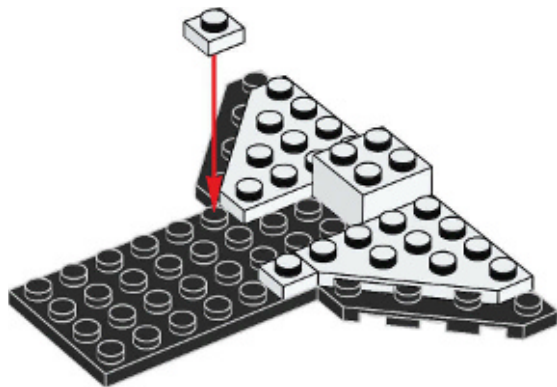



1x

6



2x



2x

7



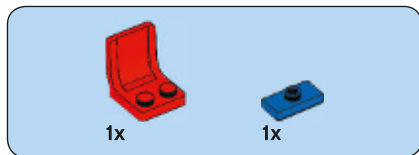

8

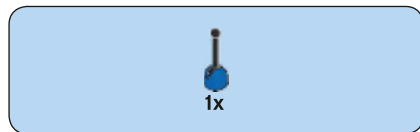
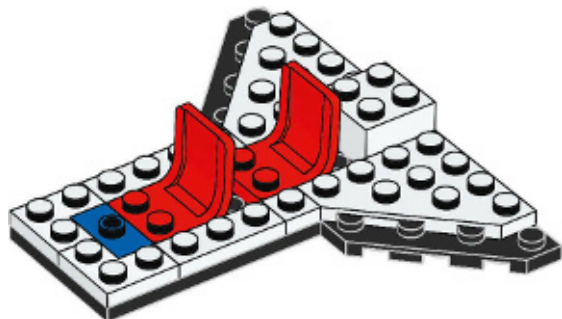

9

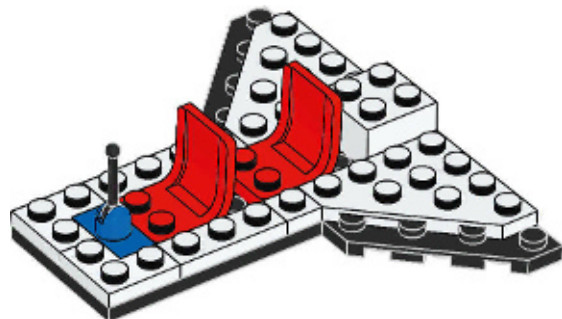

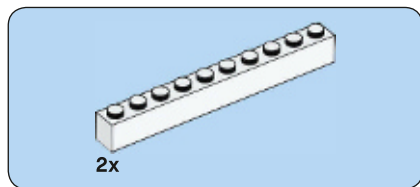

10

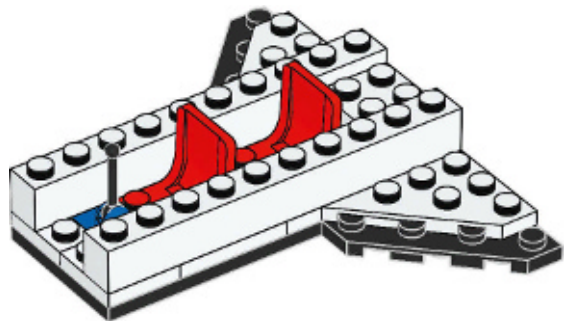

11

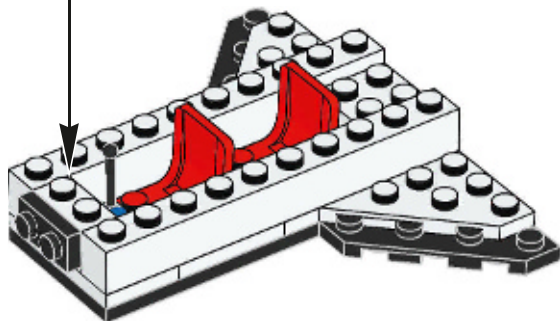
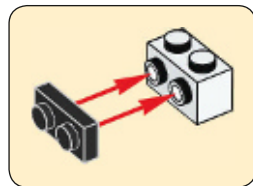



1x

12

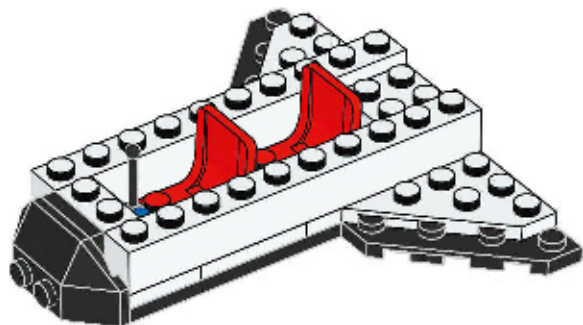

52

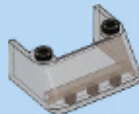

1x

13

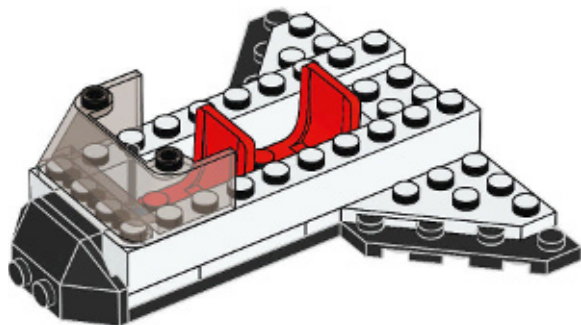



2x

14

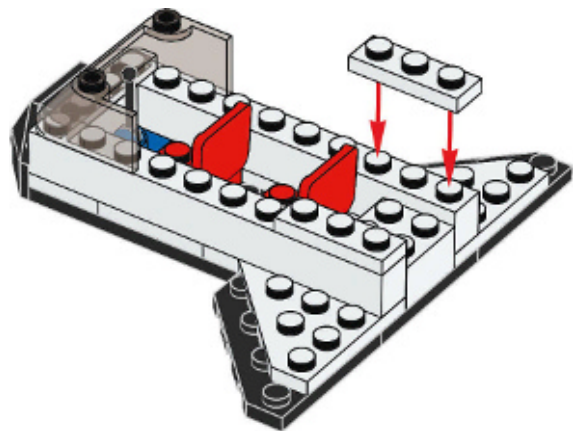

1x



1x

15

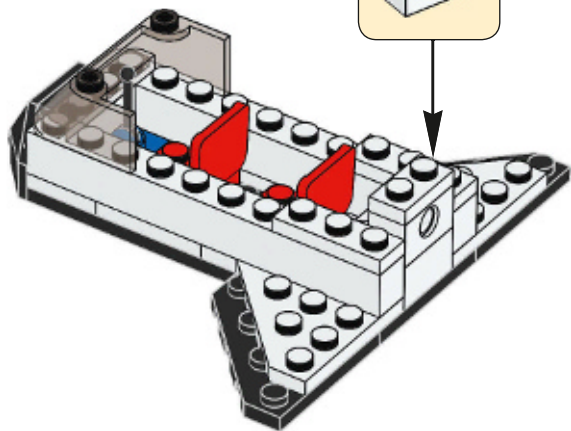



6x

16

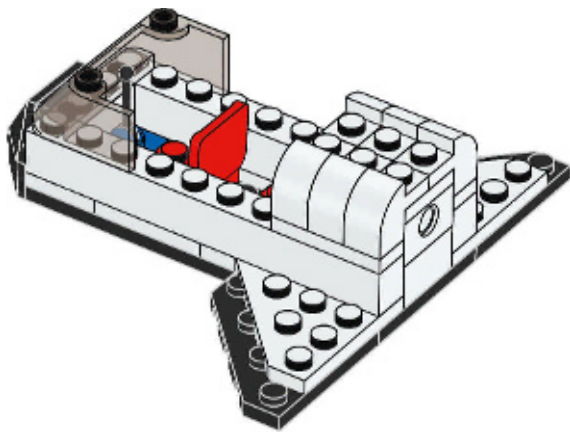



1x



2x

17

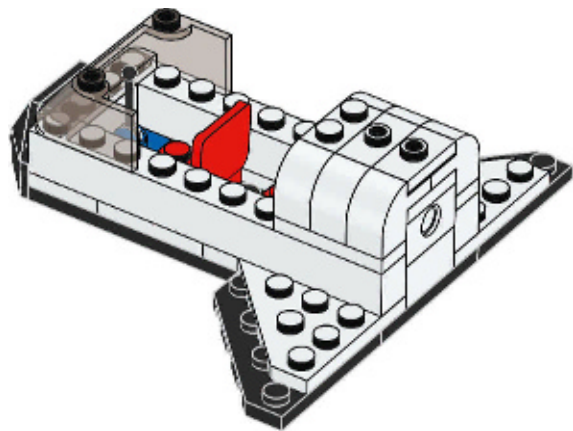

1x



1x

18

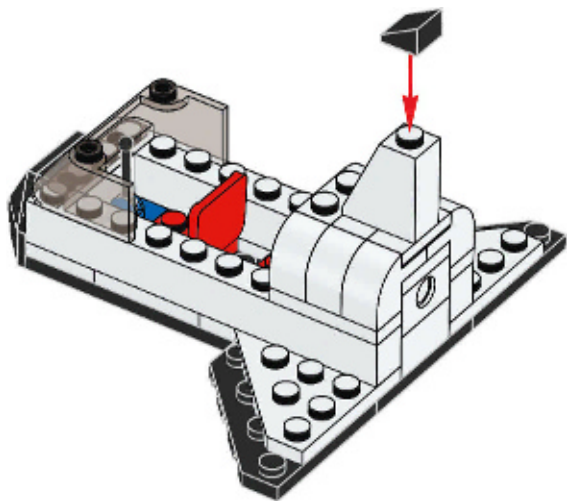

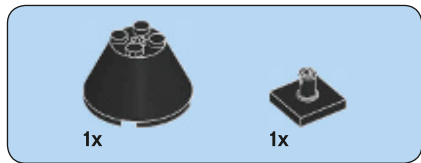

19

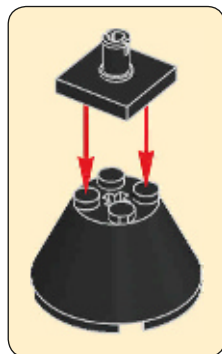
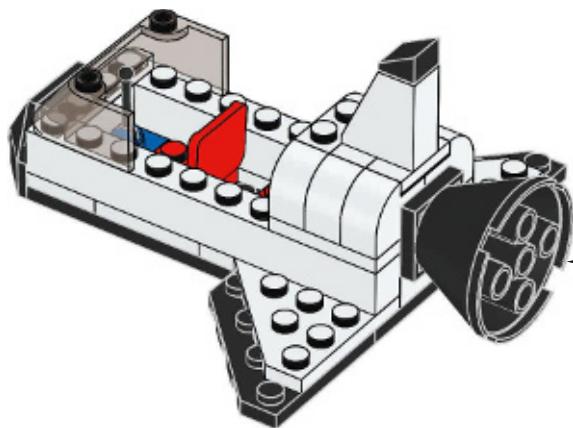



1x

20

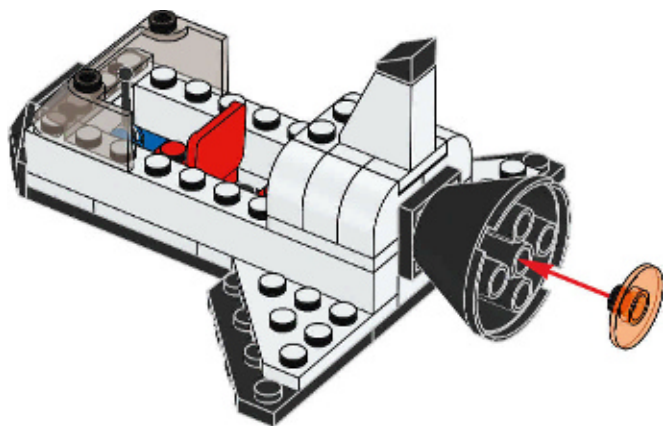

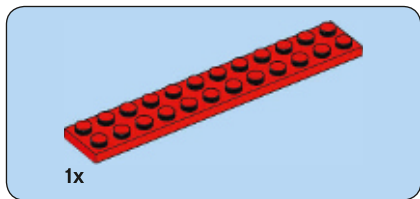
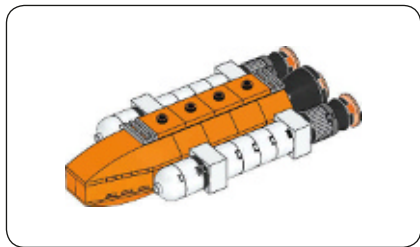

1x

21

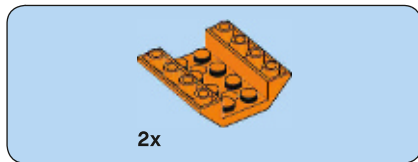
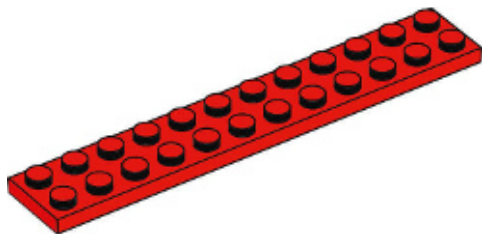

2x

22

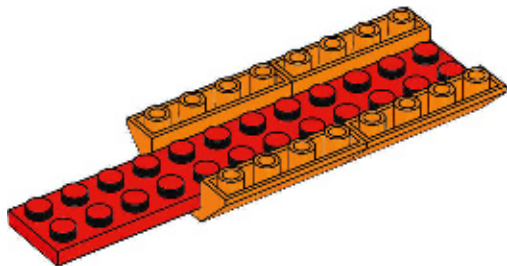

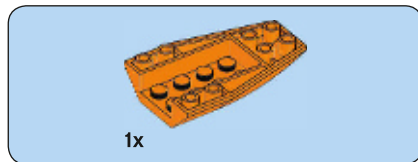

23

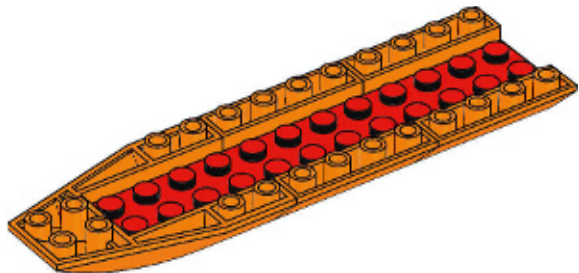

24

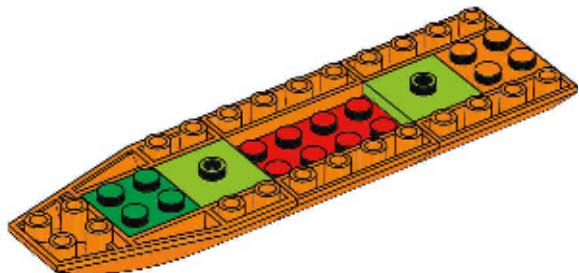



1x

25

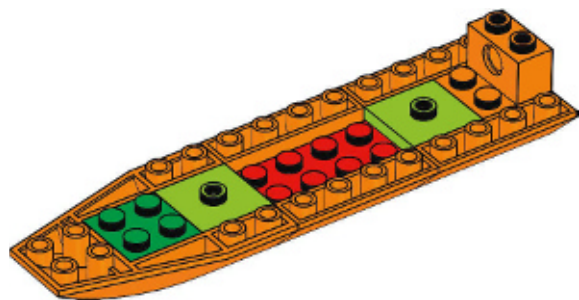

1x



2x

26

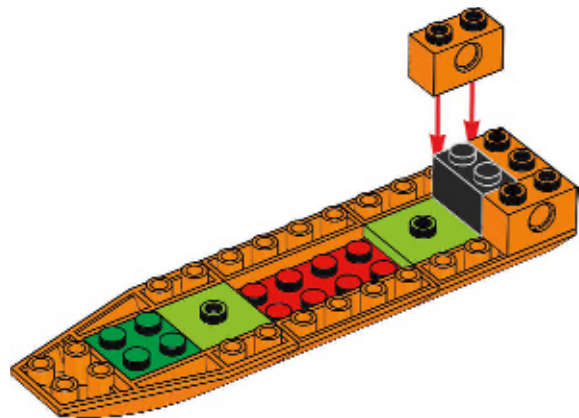

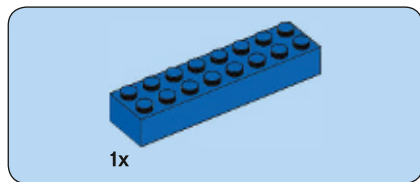

27

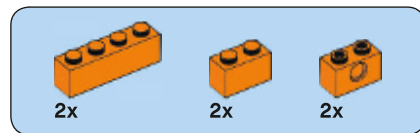
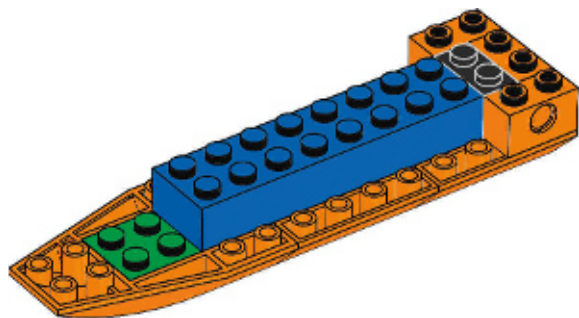

28

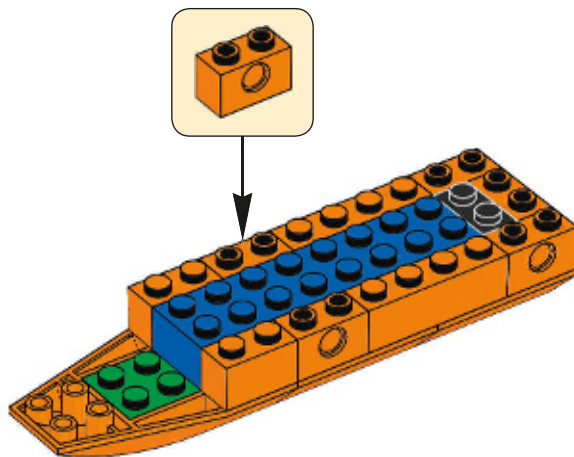

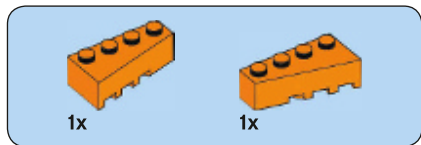

29

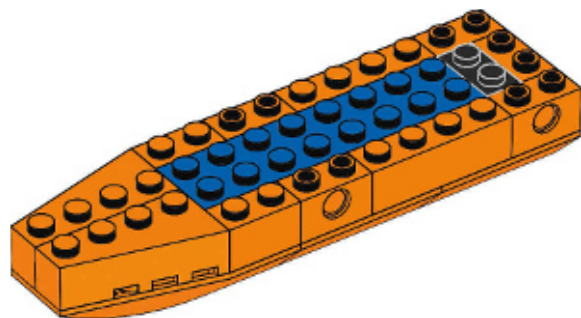

30

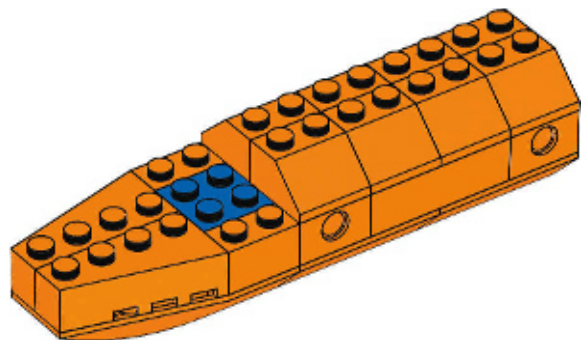

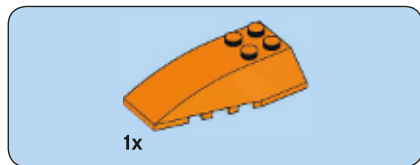

31

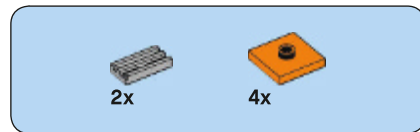
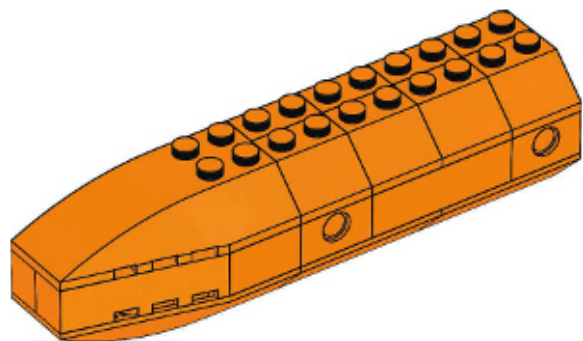

32

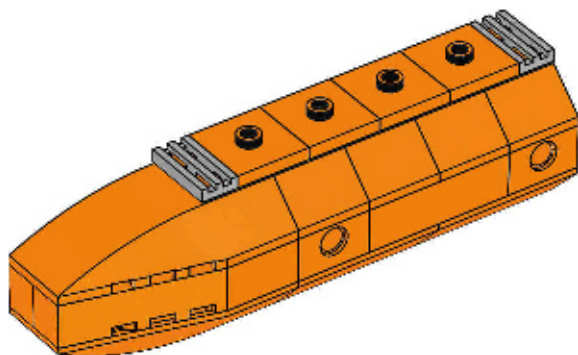

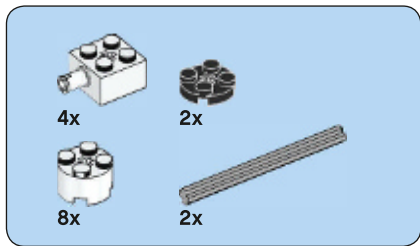
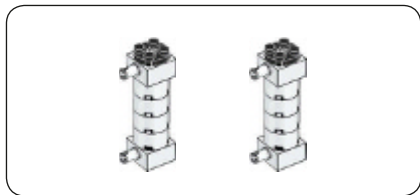

33

1

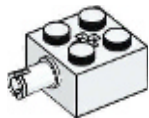

2

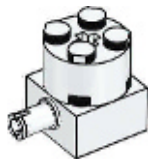

3

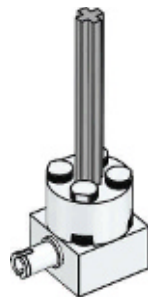

4

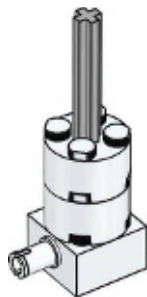

5

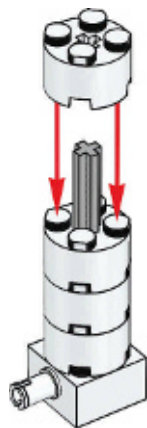

6

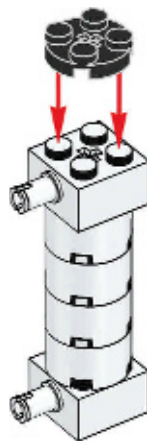

2x

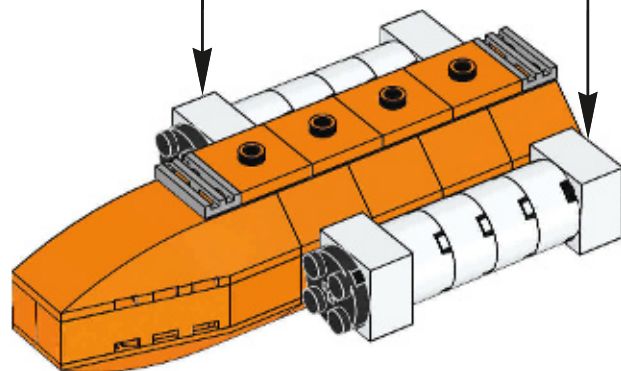



2x



2x

34

1



2



2x

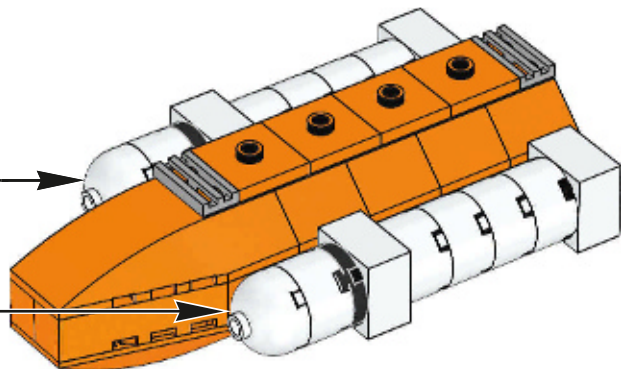

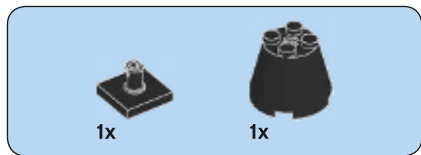

35

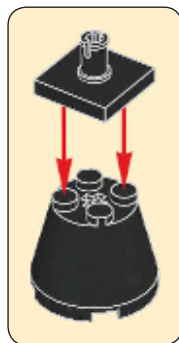
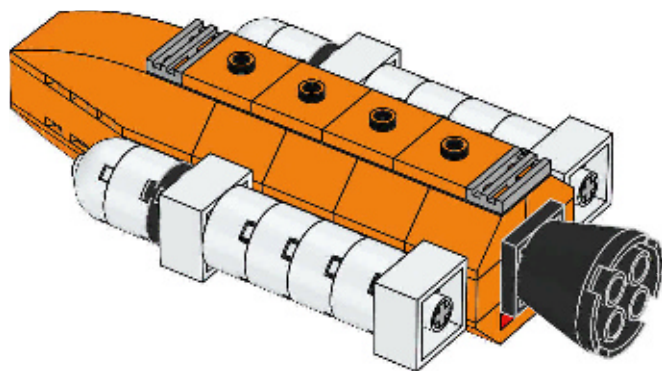



1x

36

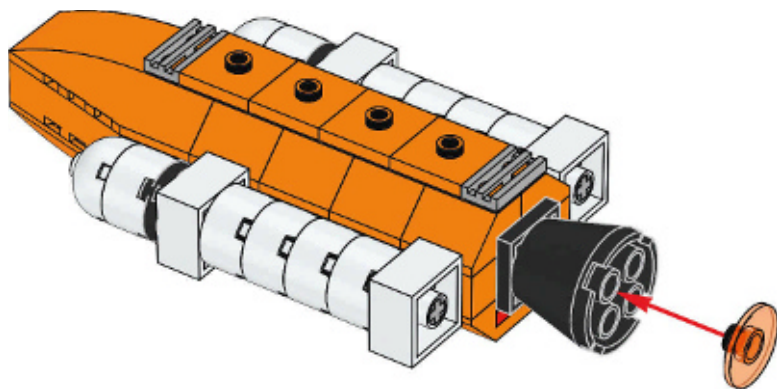



37

1



2

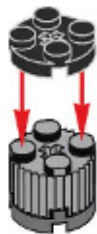

3

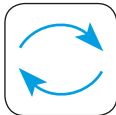

4



2x

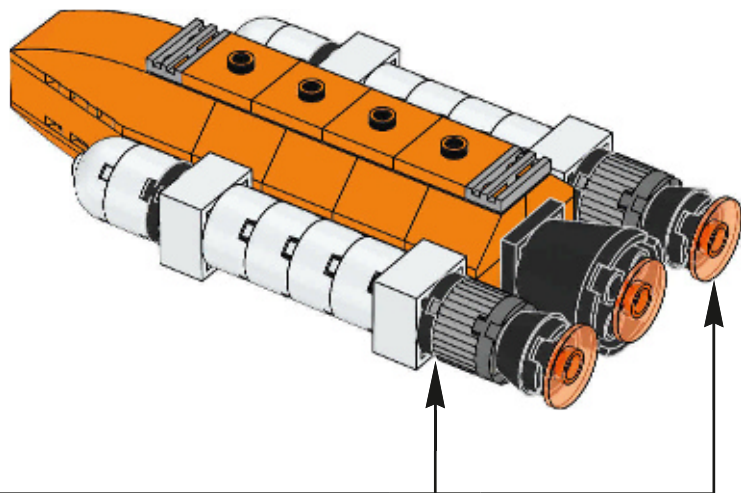

38

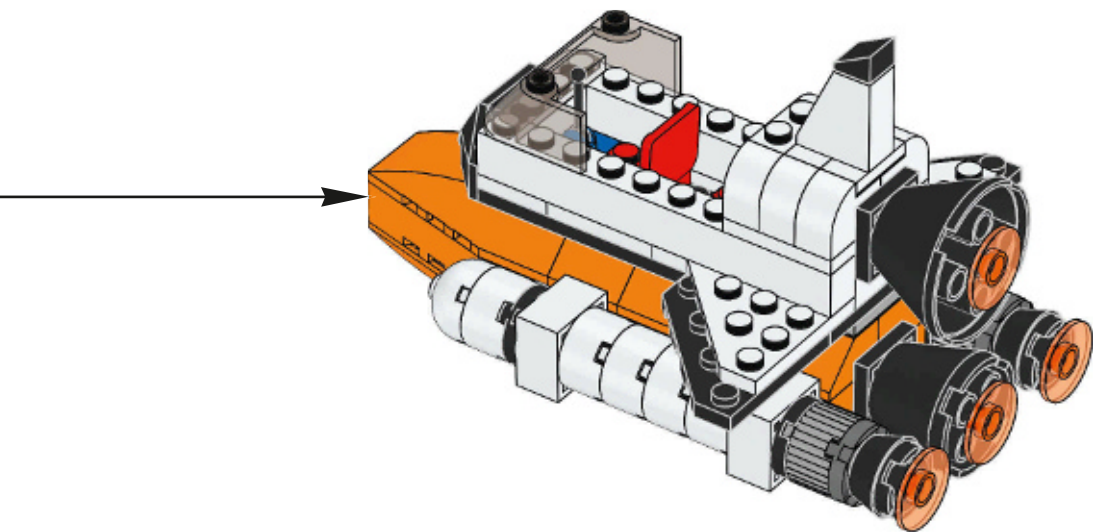

how can



get to Mars?

comment



peut se rendre
sur Mars ?

¿cómo puede llegar



a Marte?

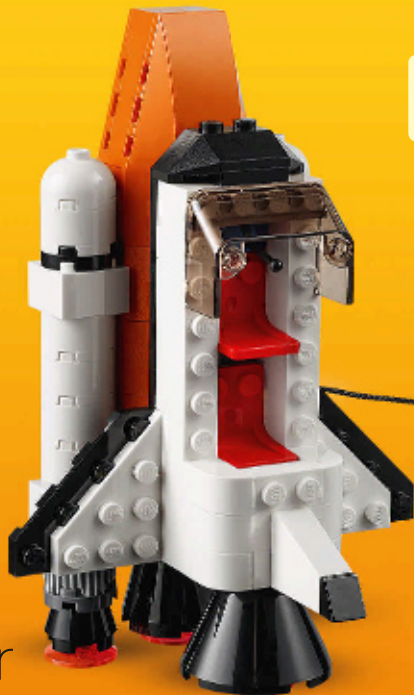

Upload your build at / Télécharge ta construction sur / Carga tu modelo en



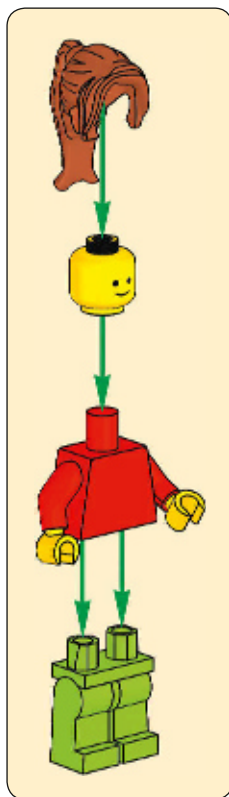

4x 614101	2x 6046381	1x 4297083	4x 301001	4x 4159553	1x 4509897	2x 449521	2x 4255035	2x 306224
6x 6029156	2x 6051511	4x 242001	4x 301001	2x 4113915	4x 393721	2x 302121	4x 303923	3x 9336
2x 6097402	2x 6058177	4x 300301	2x 4530590	1x 6093519	4x 614121	6x 4121934	4x 4543998	8x 4624985
1x 6139343	2x 6058177	4x 300301	1x 6218943	2x 4109995	1x 6159427	2x 6138800	1x 9341	1x 4114584
8x 6194809	6x 609101	4x 4490141	1x 6218943	2x 4109995	1x 4538780	2x 6135130	2x 6092582	4x 414324
4x 302401	2x 370001	4x 362301	4x 300101	4x 4114306	2x 4558886	2x 302221	4x 300423	4x 300424
2x 4298609	4x 302301	4x 4143137	2x 4160215	2x 6172807	1x 389921	4x 4567445	4x 300423	4x 300424
4x 6060734	4x 302301	4x 4143137	2x 4160215	2x 6172807	1x 389921	2x 366021	2x 4514398	4x 302324
2x 4216652	2x 245401	2x 6089574	1x 4646574	2x 6122047	1x 6054438	4x 300321	1x 368023	4x 302324
10x 614301	2x 6097637	2x 6089574	1x 4646574	2x 6122047	4x 6066342	4x 300321	1x 6055101	4x 302324
2x 4515370	2x 6097637	4x 329801	2x 611101	2x 6079724	3x 4650646	2x 407921	2x 4195007	4x 4121965
							4x 300323	4x 300324
							4x 6037384	4x 300324

2x
366024

4x
362224

4x
371024

1x
4561507

2x
4181143

1x
303324

1x
4275872

1x
4502268

1x
4275461

2x
4296152

1x
4538456

1x
6205490

2x
6066102

4x
4504382

2x
4558954

8x
4578677

8x
403226

2x
6106280

1x
4106552

2x
300426

2x
6092585

4x
302326

2x
4569733

2x
4653822

1x
6185327

2x
6016172

2x
4584274

1x
4540699

2x
6116990

2x
302226

1x
4529064

2x
4258354

1x
6051038

1x
4500978

1x
400626

4x
460026

2x
6188706

1x
6170545

2x
4162443

1x
6096955

4x
4619323

1x
4515350

1x
4143243

2x
302026

4x
292626

2x
4217725

2x
4160025

1x
6096955

1x
303026

8x
4569058

2x
300528

4x
6171061

1x
6032177

4x
403228

4x
4121969

2x
4272665

2x
302228

4x
300328

4x
4107637

2x
449528

2x
6021539

2x
302028

4x
4647553

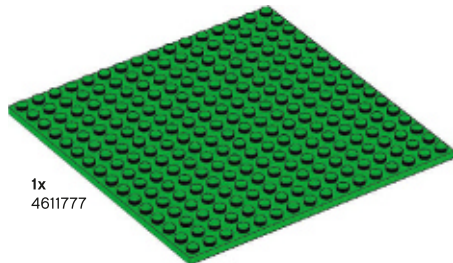

1x
4611777

2x
6143431

2x
4666322

4x
6186012

1x
4614107

1x
4273743

4x
6186009

2x
6092602

2x
6069259

2x
6212082

4x
3005740

1x
3000240

2x
6000740

2x
306540

2x
6054554

1x
4521504

4x
4646864

2x
6056842

4x
3005744

4x
3006347

1x
4568173





































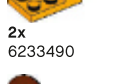













































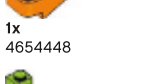









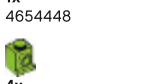





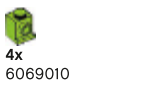

2x
6073445

2x
4499885

2x
6051918

2x
6013633

1x
382342

 2x 6195548	 1x 6209675	 2x 6231520	 2x 6056291	 2x 4261397	 4x 6023173	 2x 6097511	 2x 6075208	 2x 6109924	 4x 4211410
 2x 6185356	 1x 6209675	 2x 6207370	 4x 4650630	 6x 4521914	 1x 6020145	 2x 6233490	 1x 4252456	 4x 4211350	 1x 4622060
 2x 6172934	 2x 4125278	 2x 6207370	 2x 4220632	 2x 4528604	 1x 6020145	 2x 6233490	 2x 4216695	 4x 6152107	 1x 4622060
 6x 6136553	 2x 4125278	 2x 6207370	 2x 4220632	 2x 6003379	 1x 6020146	 1x 4211158	 2x 4508616	 6x 4529241	 2x 6129340
 2x 4121739	 2x 4118827	 1x 4654448	 2x 6231519	 2x 6003379	 2x 6024286	 2x 6075213	 2x 4211186	 8x 4521921	 2x 4211363
 4x 4177932	 1x 6220701	 1x 4654448	 2x 4234716	 2x 6218456	 2x 6024286	 4x 4211166	 2x 4211186	 2x 4650645	 2x 4211568
 4x 6126063	 2x 4153827	 2x 6092766	 2x 6121903	 2x 4550329	 4x 6172370	 4x 4223303	 2x 4211201	 1x 4540203	 4x 6126082
 2x 4159007	 2x 4153827	 2x 6172932	 2x 4537936	 4x 6093908	 4x 6022064	 2x 6092590	 2x 6039192	 1x 4211827	 4x 4211397
 4x 4153825	 1x 6220703	 1x 6125731	 6x 6177349	 8x 4609925	 4x 6022064	 2x 6186045	 2x 4221590	 2x 4211470	 2x 6212077
 8x 4118828	 2x 6186382	 2x 6138122	 4x 4244369	 2x 6152321	 2x 6134876	 2x 6117976	 2x 4243838	 4x 4211437	 6x 4211387

7



2x
4211805



15x
4211090



8x
4210633



1x
4211051



4x
4587212



2x
4211042



1x
4502068



4x
6000853



4x
4211133



2x
4211076



2x
4210875



2x
4257526



1x
4211114



2x
4621545



6x
6057387



2x
6056381



10x
6056413



2x
6054406



4x
4517992



1x
6097228



2x
6056263



2x
6233491



2x
4621554



2x
4654128



2x
6096589



2x
4550359



2x
6063897



2x
6234529



2x
4622176



2x
4655695



2x
6104154



2x
6047422



2x
6133921



2x
4225142



4x
4523159



1x
4512021



4x
6022105



2x
6127366



2x
4538950



1x
4622738



1x
6020190



1x
6167073



1x
6167074



4x
4653988



4x
6004943



2x
6212973



2x
6036490



2x
4619653

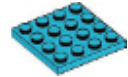

2x
6141594

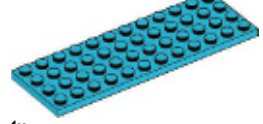

1x
6056270



2x
6107188



2x
4655173



2x
6078236



2x
6051541



2x
4163306



1x
4124083



Customer Service

Kundenservice

Service Consommateurs

Servicio Al Consumidor

LEGO.com/service or dial



00800 5346 5555 :



1-800-422-5346 :



LEGO Friends



LEGO CLASSIC



LEGO CITY



WIN

GO TO WWW.LEGO.COM/PRODUCTFEEDBACK AND
GIVE US YOUR SHORT **FEEDBACK** ABOUT THIS
LEGO® SET FOR A CHANCE TO WIN
A COOL LEGO PRIZE.

Terms & Conditions apply

LEGO.com/productfeedback



GEWINNE

Erzähle uns auf
www.LEGO.com/productfeedback

etwas über die Erfahrungen, die du mit
diesem LEGO® Set gemacht hast, und
sichere dir die Chance auf einen coolen
LEGO Preis!

Es gelten die Teilnahmebedingungen

GAGNE

Rends-toi sur
www.LEGO.com/productfeedback

et donne-nous quelques commentaires sur
ce produit LEGO® pour avoir une chance
de gagner un prix LEGO !

Voir Conditions Générales

GANAN

Visita
www.LEGO.com/productfeedback

y envíanos tu opinión acerca de este set
LEGO®. ¡Participarás en el sorteo de un
premio LEGO!

Términos y Condiciones aplicables

获取奖品

登录
www.LEGO.com/productfeedback

给出关于此乐高®套装的简短反馈，
就有机会获得炫酷乐高奖品

《条款及条件》适用